

GTVA126001EC/FC

Thermally-Enhanced High Power RF GaN HEMT
600 W, 50 V, 1200 – 1400 MHz

Description

The GTVA126001EC and GTVA126001FC are 600-watt GaN on SiC high electron mobility transistors (HEMT) for use in the 1200 to 1400 MHz frequency band. They feature input matching, high efficiency, and thermally-enhanced packages.

GTVA126001EC
Package H-36248-2

GTVA126001FC
Package H-37248-2

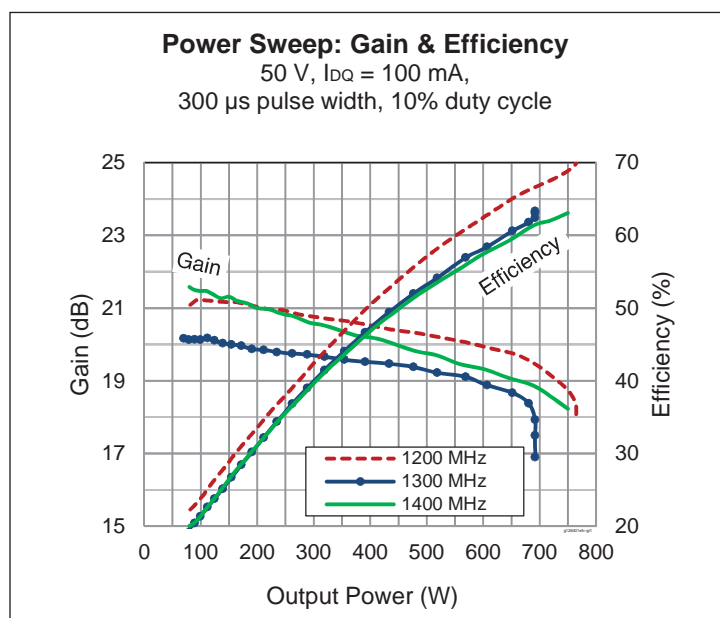
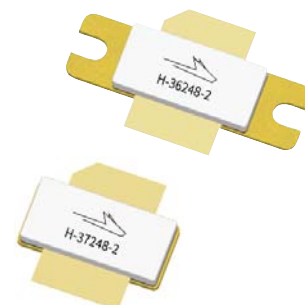

Features

- GaN on SiC HEMT technology
- Input matched
- Typical pulsed CW performance (class AB), 1200 MHz, 50 V, 300 μs pulse width, 10% duty cycle
 - Output power (P_{3dB}) = 600 W
 - Drain efficiency = 65%
 - Gain = 18 dB
- Capable of withstanding a 10:1 load mismatch (all phase angles) at 600 W peak power under pulsed conditions: 300 μs pulse width, 10% duty cycle, V_{DD} = 50 V, I_{DQ} = 100 mA
- Human Body Model Class 1C (per AnSI/ESDA/JEDEC JS-001)
- Pb-free and RoHS compliant

RF Characteristics

Pulsed RF Performance (tested in Wolfspeed test fixture)

V_{DD} = 50 V, I_{DQ} = 100 mA, P_{OUT} = 600 W, f = 1400 MHz, 300 μs pulse width, 10% duty cycle

Characteristic	Symbol	Min	Typ	Max	Unit
Gain	G _{ps}	19	20	22	dB
Drain Efficiency	η _D	56	63	—	%

All published data at T_{CASE} = 25°C unless otherwise indicated

ESD: Electrostatic discharge sensitive device—observe handling precautions!

DC Characteristics

Characteristic	Conditions	Symbol	Min	Typ	Max	Unit
Drain-source Breakdown Voltage	$V_{GS} = -8\text{ V}$, $I_D = 10\text{ mA}$	$V_{(BR)DSS}$	150	—	—	V
Drain-source Leakage Current	$V_{GS} = -8\text{ V}$, $V_{DS} = 50\text{ V}$	I_{DSS}	—	—	12	mA
Gate Threshold Voltage	$V_{DS} = 10\text{ V}$, $I_D = 85\text{ mA}$	$V_{GS(th)}$	-3.8	-3.0	-2.3	V

Recommended Operating Conditions

Parameter	Conditions	Symbol	Min	Typ	Max	Unit
Drain Operating Voltage		V_{DD}	0	—	50	V
Gate Quiescent Voltage	$V_{DS} = 50\text{ V}$, $I_D = 100\text{ mA}$	$V_{GS(Q)}$	-4.3	-3.2	-2.4	V

Absolute Maximum Ratings

Parameter	Symbol	Value	Unit
Drain-source Voltage	V_{DSS}	125	V
Gate-source Voltage	V_{GS}	-10 to +2	V
Gate Current	I_G	100	mA
Drain Current	I_D	10	A
Junction Temperature	T_J	225	°C
Storage Temperature Range	T_{STG}	-65 to +150	°C

Operation above the maximum values listed here may cause permanent damage. Maximum ratings are absolute ratings; exceeding only one of these values may cause irreversible damage to the component. Exposure to absolute maximum rating conditions for extended periods may affect device reliability. For reliable continuous operation, the device should be operated within the operating voltage range (V_{DD}) specified above.

Thermal Characteristics

¹ $T_{CASE} = 70\text{ °C}$, 676 W (peak), 50 V, $I_{DQ} = 100\text{ mA}$, 1200 MHz, 2 ms pulse width, 10% duty cycle

² $T_{CASE} = 70\text{ °C}$, 630 W (peak), 50 V, $I_{DQ} = 100\text{ mA}$, 1200 MHz, 2 ms pulse width, 40% duty cycle

Characteristic	Symbol	Value	Unit
Thermal Resistance ¹	$R_{\theta JC}$	0.86	°C/W
Thermal Resistance ²	$R_{\theta JC}$	0.26	°C/W

Ordering Information

Type and Version	Order Code	Package and Description	Shipping
GTVA126001EC V1 R0	GTVA126001EC-V1-R0	H-36248-2, single-ended, bolt-down flange	Tape & Reel, 50 pcs
GTVA126001EC V1 R2	GTVA126001EC-V1-R2	H-36248-2, single-ended, bolt-down flange	Tape & Reel, 250 pcs
GTVA126001FC V1 R0	GTVA126001FC-V1-R0	H-37248-2, single-ended, earless flange	Tape & Reel, 50 pcs
GTVA126001FC V1 R2	GTVA126001FC-V1-R2	H-37248-2, single-ended, earless f flange	Tape & Reel, 250 pcs

Typical Performance

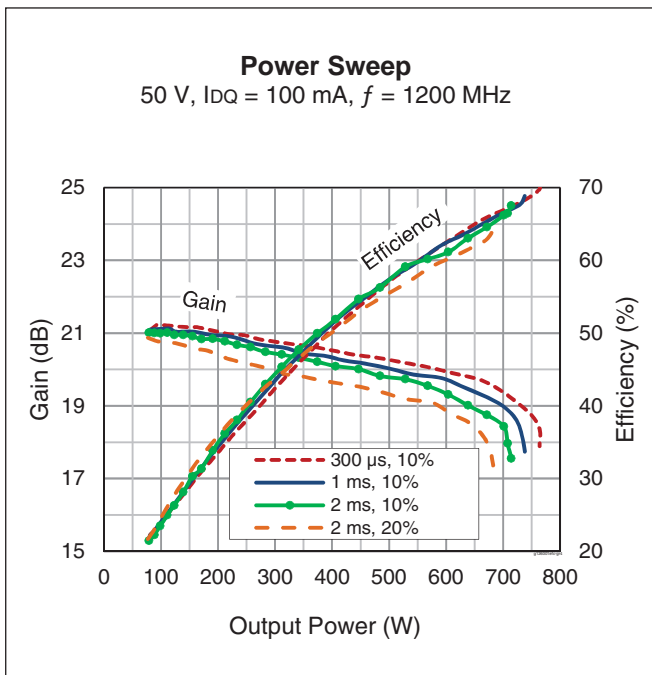
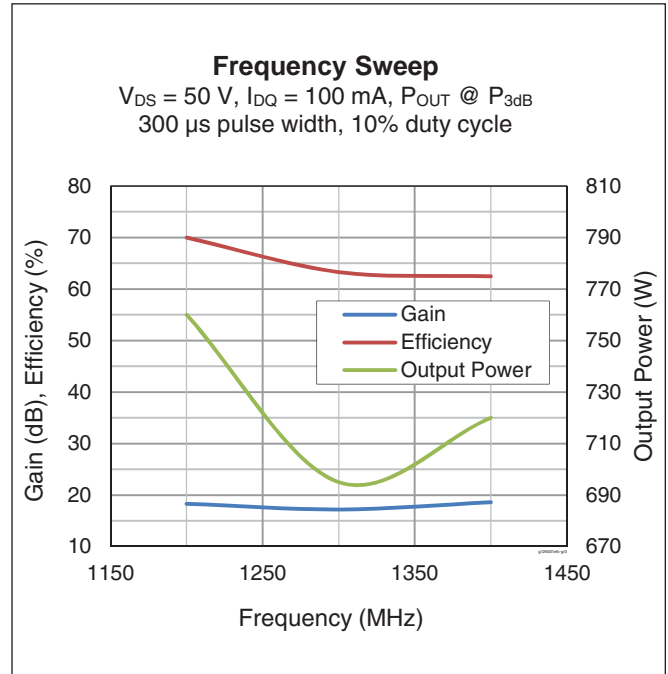
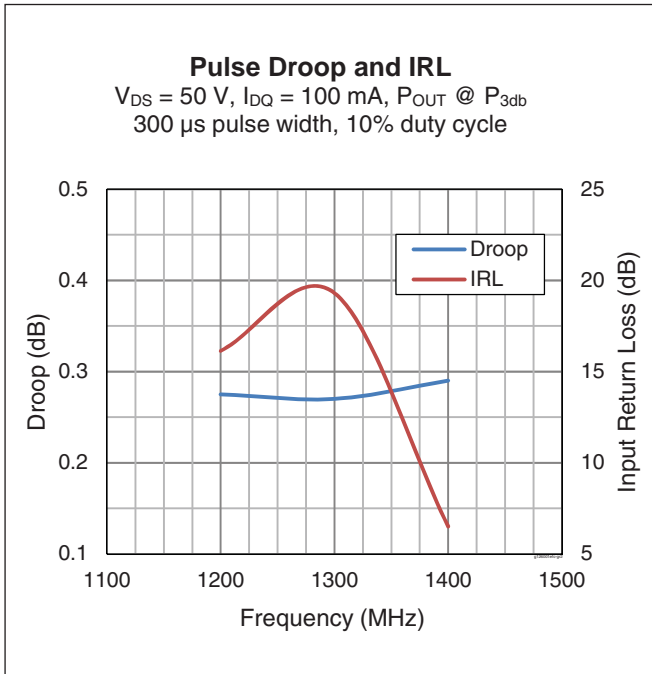

Load Pull Performance

Each Side Load Pull Performance -16 μs pulse width, 10% duty cycle, class AB, V_{DD} = 50 V, 60 mA

Freq [MHz]	Max Output Power					Max Efficiency					Z Optimum					
	P _{OUT} [dBm]	P _{OUT} [W]	Eff [%]	Gain [dB]	Z _{Load} [Ω]	P _{OUT} [dBm]	P _{OUT} [W]	Eff [%]	Gain [dB]	Z _{Load} [Ω]	P _{OUT} [dBm]	P _{OUT} [W]	Eff [%]	Gain [dB]	Z _{Load} [Ω]	Z _{Source} [Ω]
1200	59.20	832	66.29	19.34	1.54 + j0.11	58.12	649	75.83	20.09	2.19 + j0.97	59.09	811	70.51	19.79	1.68 + j0.33	1.00 - j1.73
1300	58.62	728	59.62	18.89	1.12 + j0.12	57.56	570	71.85	20.53	1.54 + j0.94	58.41	693	67.11	19.98	1.22 + j0.44	4.43 - j1.20
1400	58.55	716	59.68	19.65	1.00 + j0.21	57.35	543	70.39	20.18	1.38 + j0.85	58.27	671	65.89	20.23	1.15 + j0.45	2.35 + j0.66

Reference Circuit tuned for 1200 to 1400 MHz

DUT	GTVA126001EC/FC V1
Test Fixture Part No.	LTN/GTVA126001EC V1, LTN/GTVA126001FC V1
PCB	Rogers 4350, 0.508 mm [.020"] thick, 2 oz. copper, ε _r = 3.66
Find Gerber files for this test fixture on the Wolfspeed Web site at www.wolfspeed.com/RF	

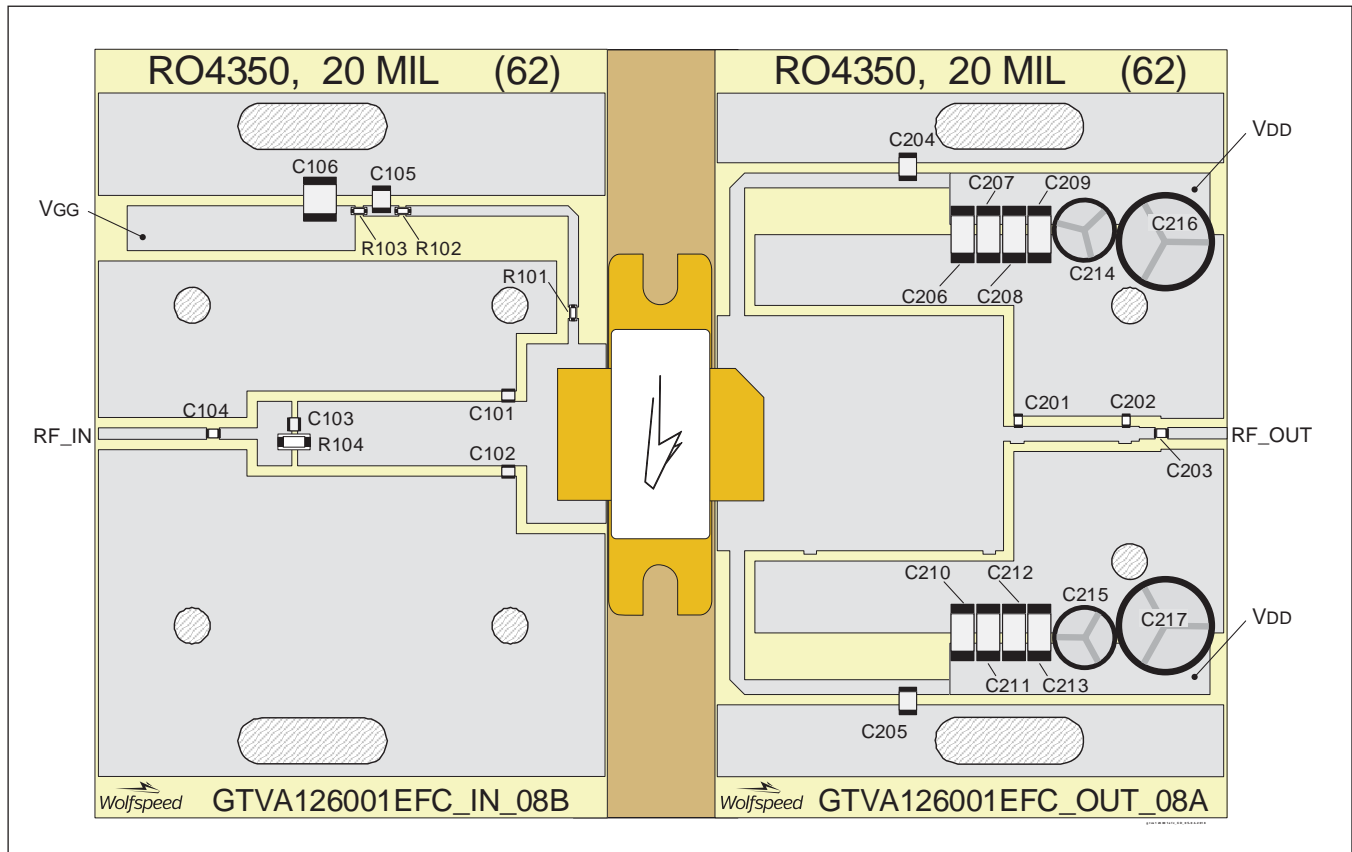

Reference circuit assembly diagram (not to scale)



Reference Circuit (cont.)

Components Information

Component	Description	Manufacturer	P/N
Input			
C101, C102	Capacitor, 1.2 pF	ATC	ATC800A1R2CT250T
C103, C104	Capacitor, 56 pF	ATC	ATC800A560JT250T
C105	Capacitor, 39 pF	ATC	ATC100B390JW500XB
C106	Capacitor, 1 μF	TDK Corporation	C4532X7R2A105M230KA
R101	Resistor, 10 ohms	Panasonic Electronic Components	ERJ-3GEYJ100V
R102	Resistor, 100 ohms	Panasonic Electronic Components	ERJ-3GEYJ101V
R103	Resistor, 5.6 ohms	Panasonic Electronic Components	ERJ-8RQJ5R6V
R104	Resistor, 30 ohms	Panasonic Electronic Components	ERJ-8GEYJ300V

Component	Description	Manufacturer	P/N
Output			
C201	Capacitor, 1.6 pF	ATC	ATC800A1R6CT250T
C202	Capacitor, 3.6 pF	ATC	ATC100A3R6CW150XB
C203	Capacitor, 56 pF	ATC	ATC800A560JT250T
C204, C205	Capacitor, 39 pF	ATC	ATC100B390JW500XB
C206, C207, C208, C209, C210, C211, C212, C213	Capacitor, 10 μF, 100 V	TDK Corporation	C5750X7S2A106M230KB
C214, C215	Capacitor, 22 μF	Cornell Dubilier Electronics (CDE)	SEK220M100ST
C216, C217	Capacitor, 220 μF	Panasonic Electronic Components	ECA-2AHG221

Pinout Diagram (top view)

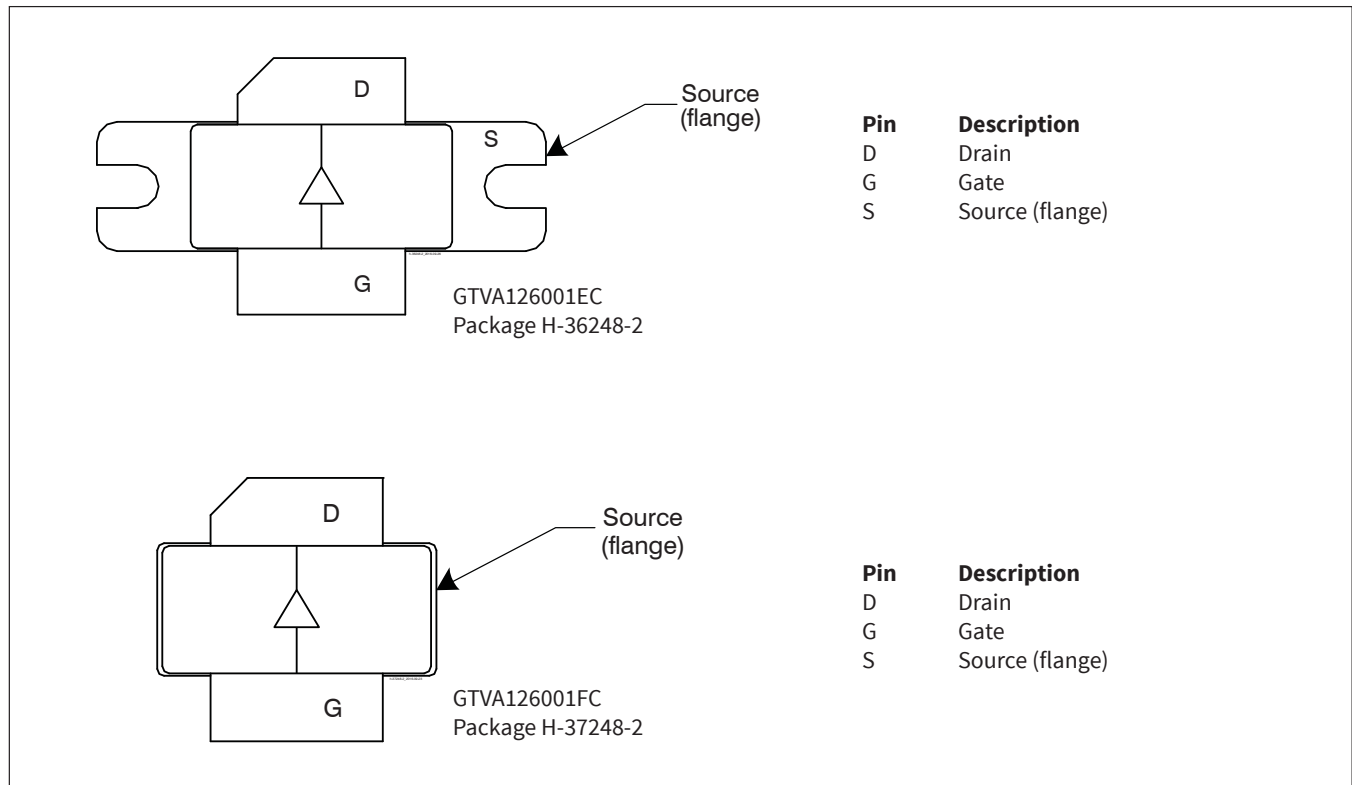

Package Outline Specifications

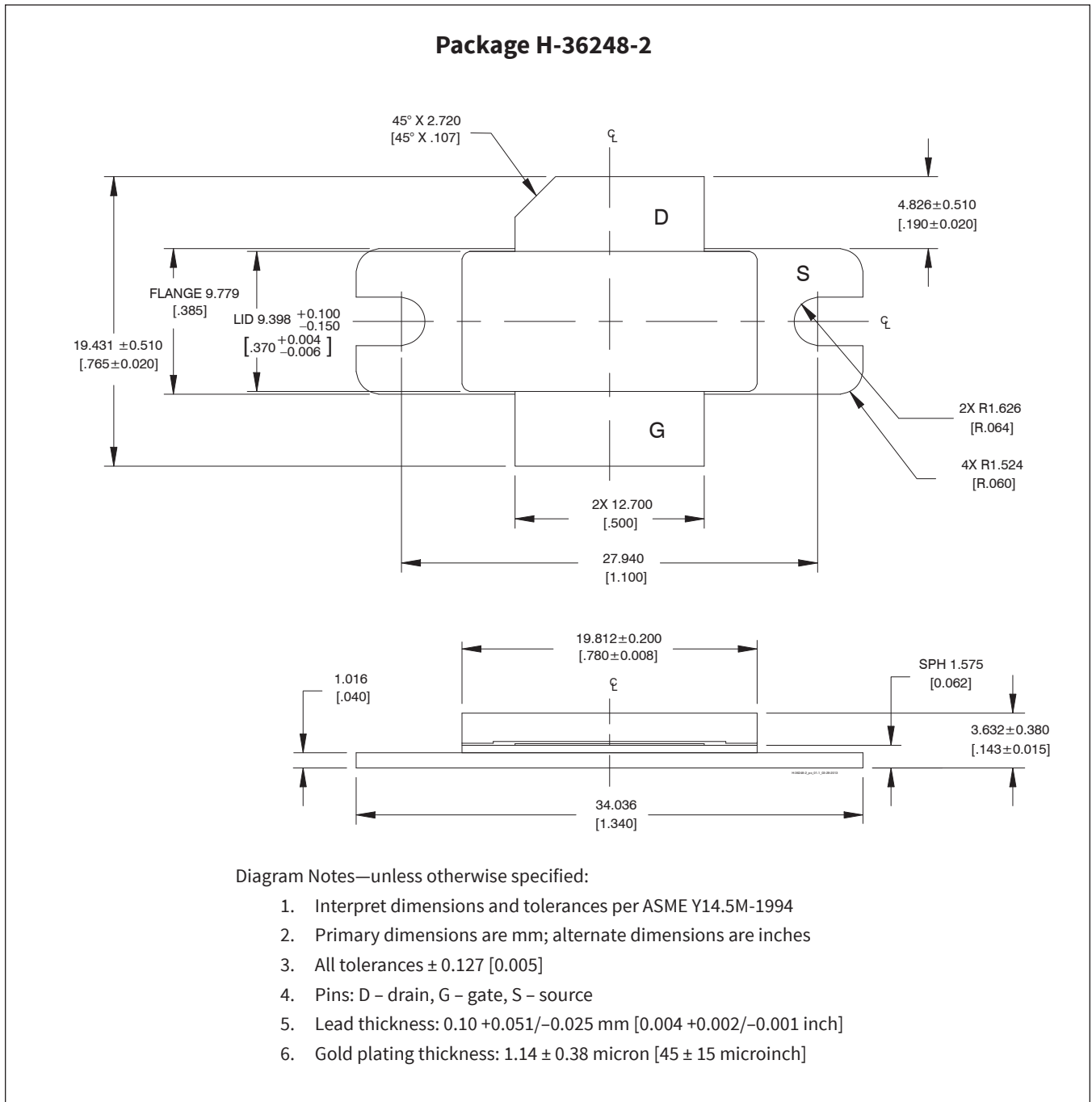

Package Outline Specifications (cont.)

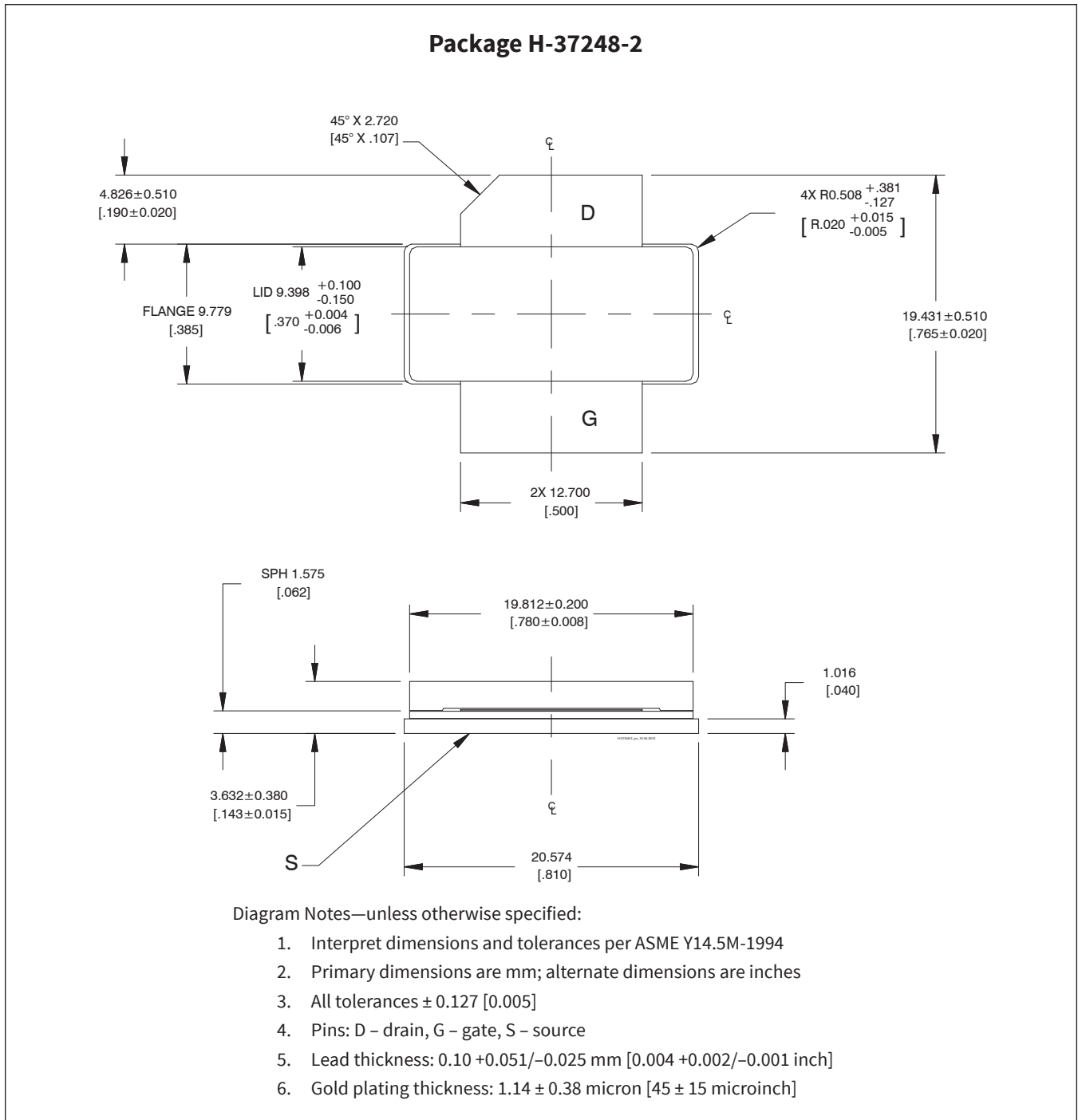

Revision History

Revision	Date	Data Sheet	Page	Subjects (major changes at each revision)
01	2016-09-27	Advance	all	Proposed specification for new product development
02	2017-07-10	Advance	all	Includes GTVA126001FC product, package H-37248-4
03	2017-11-17	Preliminary	All	Add preliminary performance information and circuit specifications
04	2018-05-01	Preliminary	All	Converted to Wolfspeed Data Sheet
05	2019-02-06	Production	All	Information for production-released device, including firm specifications, operating conditions and performance, and reference circuit specifications.

For more information, please contact:

4600 Silicon Drive
Durham, North Carolina, USA 27703
www.wolfspeed.com/RF

Sales Contact
RFSales@wolfspeed.com

RF Product Marketing Contact
RFMarketing@wolfspeed.com
919.407.7816

Notes

Disclaimer

Specifications are subject to change without notice. Cree, Inc. believes the information contained within this data sheet to be accurate and reliable. However, no responsibility is assumed by Cree for any infringement of patents or other rights of third parties which may result from its use. No license is granted by implication or otherwise under any patent or patent rights of Cree. Cree makes no warranty, representation or guarantee regarding the suitability of its products for any particular purpose. "Typical" parameters are the average values expected by Cree in large quantities and are provided for information purposes only. These values can and do vary in different applications and actual performance can vary over time. All operating parameters should be validated by customer's technical experts for each application. Cree products are not designed, intended or authorized for use as components in applications intended for surgical implant into the body or to support or sustain life, in applications in which the failure of the Cree product could result in personal injury or death or in applications for planning, construction, maintenance or direct operation of a nuclear facility.