

PTRA084808NF

Thermally-Enhanced High Power RF LDMOS FET 550 W, 48 V, 734 – 821 MHz

Description

The PTRA084808NF is a 550-watt LDMOS FET intended for use in multi-standard cellular power amplifier applications in the 734 to 821 MHz frequency band. Features include input matching, high gain and thermally-enhanced package with earless flanges. Manufactured with Wolfspeed's advanced LDMOS process, this device provides excellent thermal performance and superior reliability.

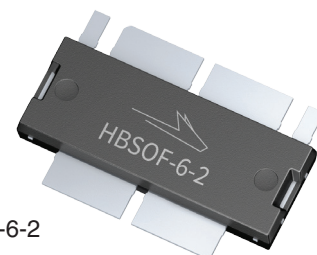

PTRA084808NF
Package PG-HBSOF-6-2

Features

- Broadband internal matching
- Asymmetric design
 - Main: $P_{1dB} = 200$ W typical
 - Peak: $P_{1dB} = 350$ W typical
- Typical pulsed CW performance (class AB), 800 MHz, 48 V, 10 μ s pulse width, 10% duty cycle, Doherty configuration
 - Output power at $P_{3dB} = 550$ W
 - Efficiency = 56%
 - Gain = 18.5 dB
- Capable of handling 10:1 VSWR at 48 V, 89 W (CW) output power
- Integrated ESD protection
- Human Body Model Class 1C (per ANSI/ESDA/ JEDEC JS-001)
- Low thermal resistance
- Pb-free and RoHS compliant

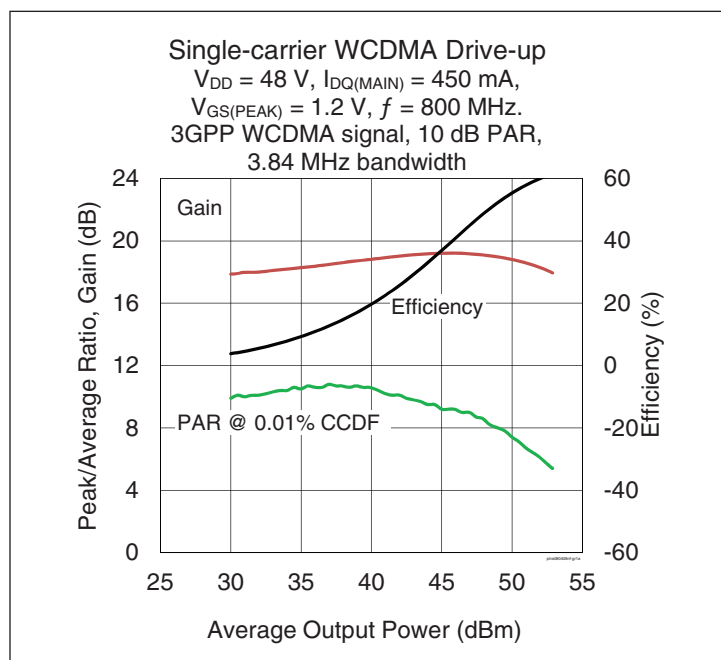

RF Characteristics

Single-carrier WCDMA Specifications (tested in Wolfspeed Doherty test fixture)

$V_{DD} = 48$ V, $I_{DQ} = 450$ mA, $V_{GS(PEAK)} = 1.2$ V, $P_{OUT} = 87$ W avg, $f = 800$ MHz. 3GPP signal, channel bandwidth = 3.84 MHz, peak/average = 10 dB @ 0.01% CCDF.

Characteristic	Symbol	Min	Typ	Max	Unit
Gain	G_{ps}	17.5	18.2	—	dB
Drain Efficiency	η_D	52.5	55	—	%
Adjacent Channel Power Ratio	ACPR	—	-30	-27.5	dBc
Output PAR at 0.01% CCDF	OPAR	6.5	7	—	dB

All published data at $T_{CASE} = 25^\circ\text{C}$ unless otherwise indicated

ESD: Electrostatic discharge sensitive device—observe handling precautions!



DC Characteristics (each side)

Characteristic	Conditions	Symbol	Min	Typ	Max	Unit
Drain-Source Breakdown Voltage	$V_{GS} = 0\text{ V}, I_{DS} = 10\text{ mA}$	$V_{(BR)DSS}$	105	—	—	V
Drain Leakage Current	$V_{DS} = 50\text{ V}, V_{GS} = 0\text{ V}$	I_{DSS}	—	—	1	μA
	$V_{DS} = 105\text{ V}, V_{GS} = 0\text{ V}$	I_{DSS}	—	—	10	μA
Gate Leakage Current	$V_{GS} = 10\text{ V}, V_{DS} = 0\text{ V}$	I_{GSS}	—	—	1	μA
On-State Resistance	(Main) $V_{GS} = 10\text{ V}, V_{DS} = 0.1\text{ V}$	$R_{DS(on)}$	—	0.08	—	Ω
	(Peak) $V_{GS} = 10\text{ V}, V_{DS} = 0.1\text{ V}$	$R_{DS(on)}$	—	0.05	—	Ω
Operating Gate Voltage	(Main) $V_{DS} = 48\text{ V}, I_{DQ} = 0.45\text{ A}$	V_{GS}	3.0	3.5	4	V
	(Peak) $V_{DS} = 48\text{ V}, I_{DQ} = 0\text{ mA}$	V_{GS}	—	1.2	—	V

Maximum Ratings

Parameter	Symbol	Value	Unit
Drain-Source Voltage	V_{DSS}	105	V
Gate-Source Voltage	V_{GS}	-6 to +12	V
Operating Voltage	V_{DD}	0 to +55	V
Junction Temperature	T_J	225	$^{\circ}\text{C}$
Storage Temperature Range	T_{STG}	-65 to +150	$^{\circ}\text{C}$

Thermal Characteristics

$T_{CASE} = 70^{\circ}\text{C}, 87\text{ W (CW)}, 48\text{ V}, I_{DQ} = 450\text{ mA}, 800\text{ MHz}$

Characteristic	Symbol	Value	Unit
Thermal Resistance	$R_{\theta JC}$	0.51	$^{\circ}\text{C/W}$

Ordering Information

Type and Version	Order Code	Package and Description	Shipping
PTRA084808NF V1 R5	PTRA084808NF-V1-R5	PG-HBSOF-6-2, plastic overmold	Tape & Reel, 500 pcs

Typical Performance (data taken in Wolfspeed production test fixture)

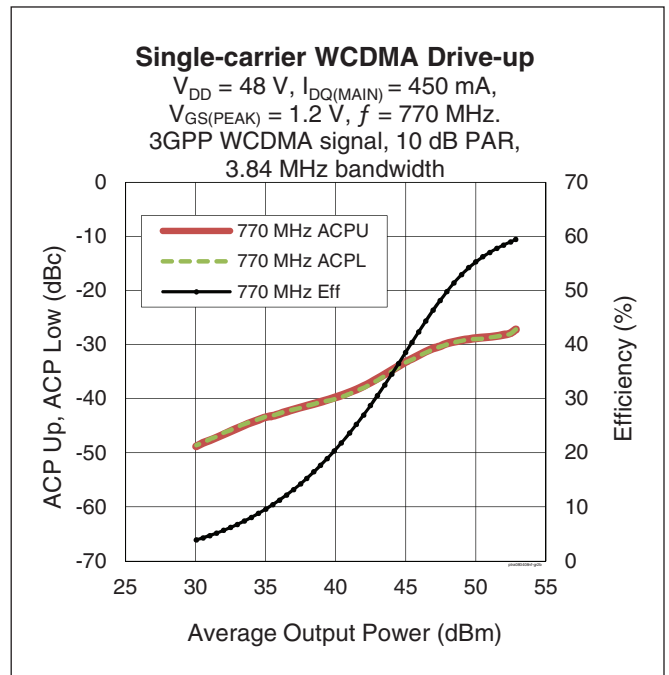
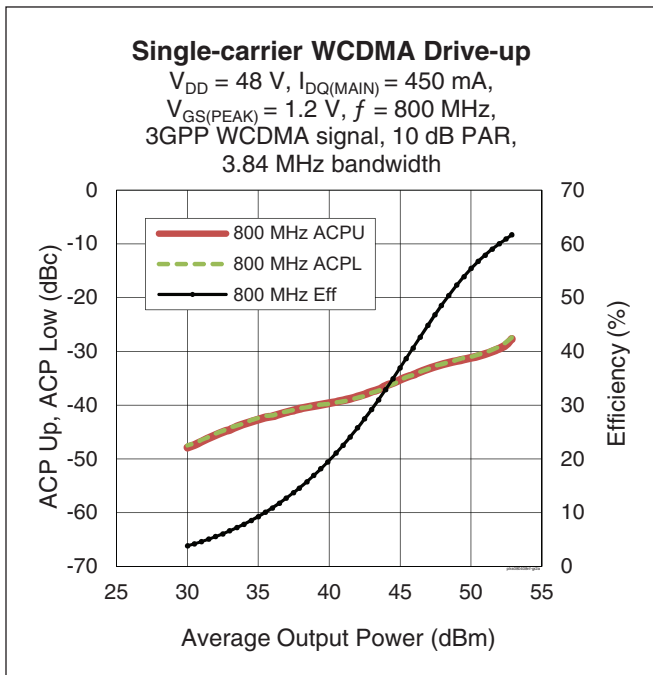
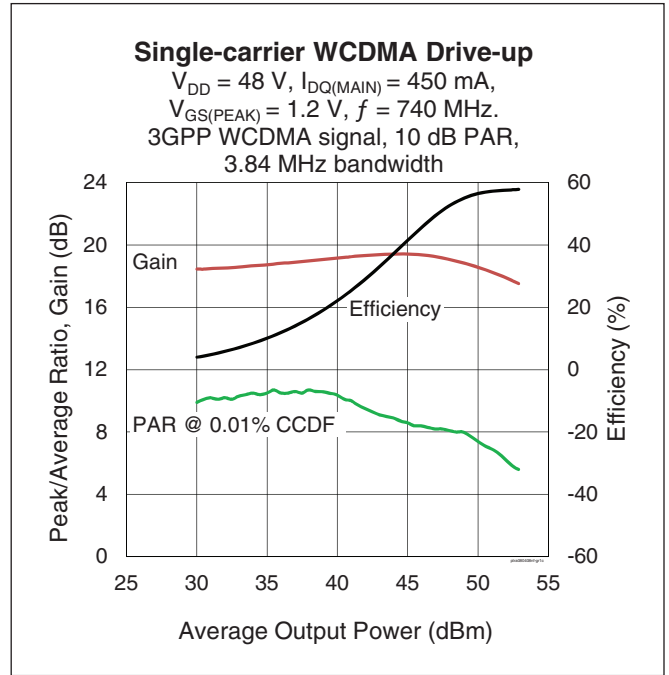
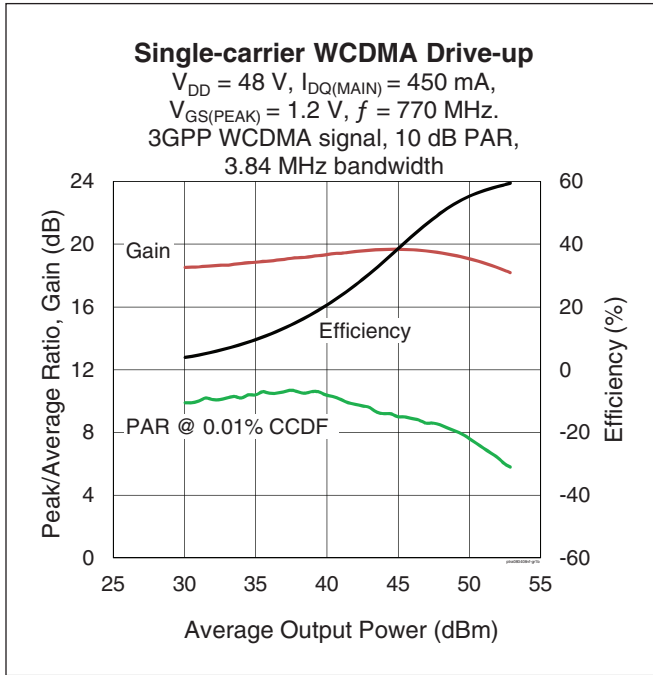



Typical Performance (cont.)

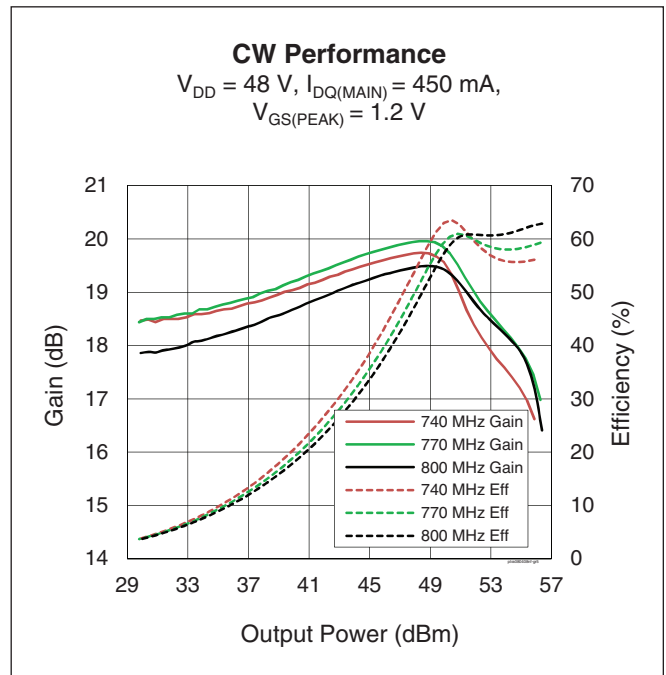
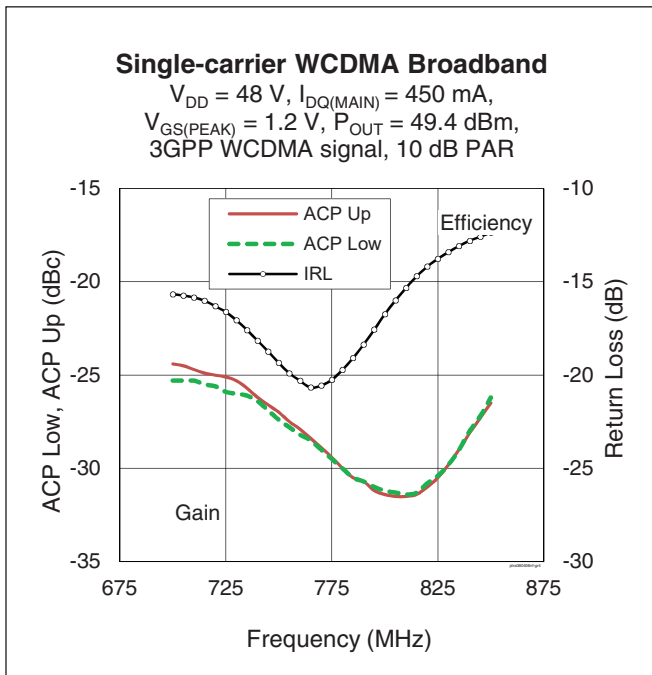
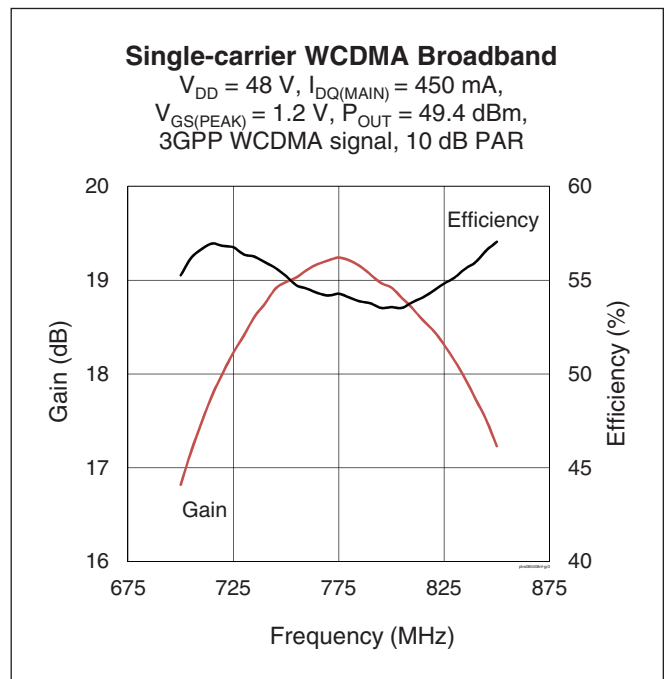
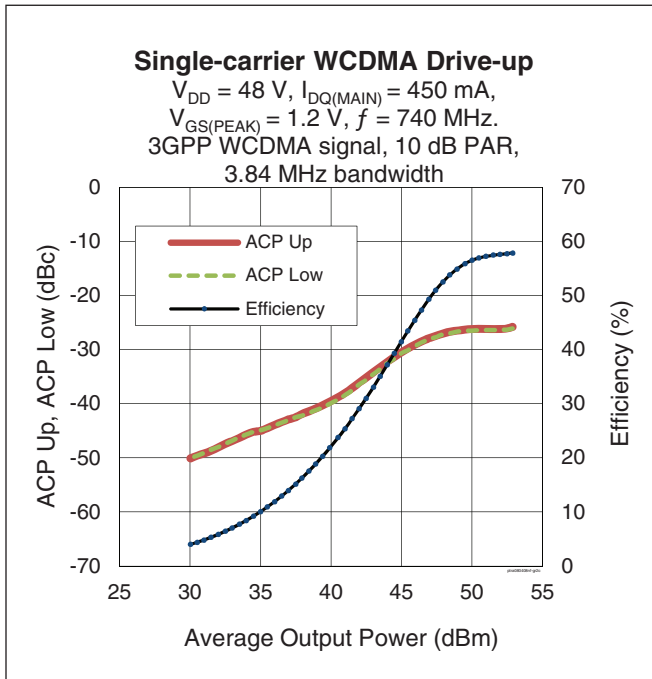

Typical Performance (cont.)

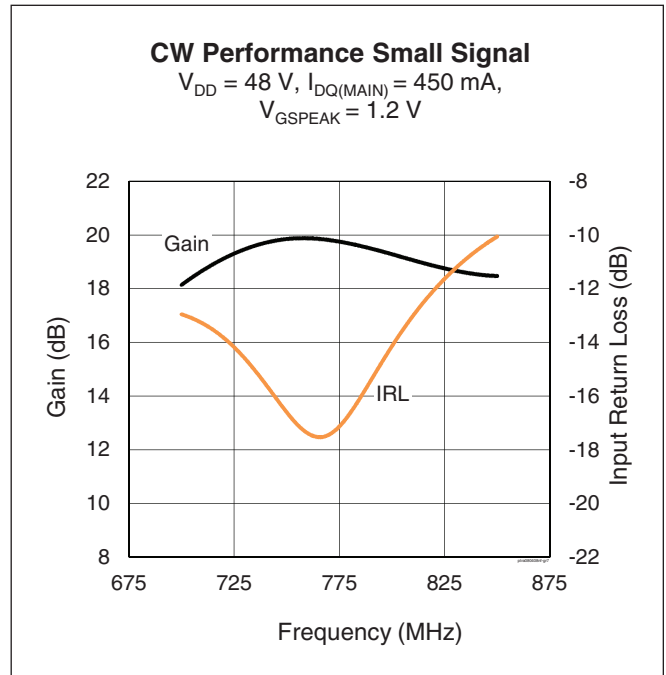
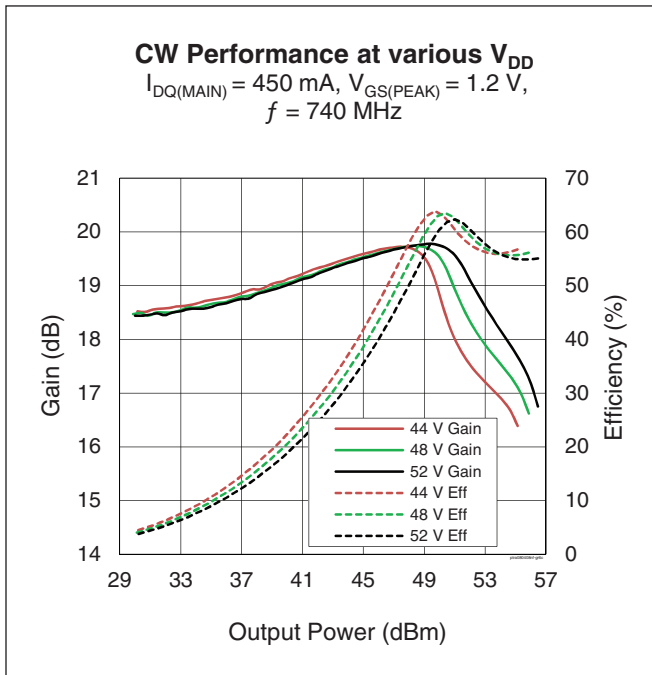
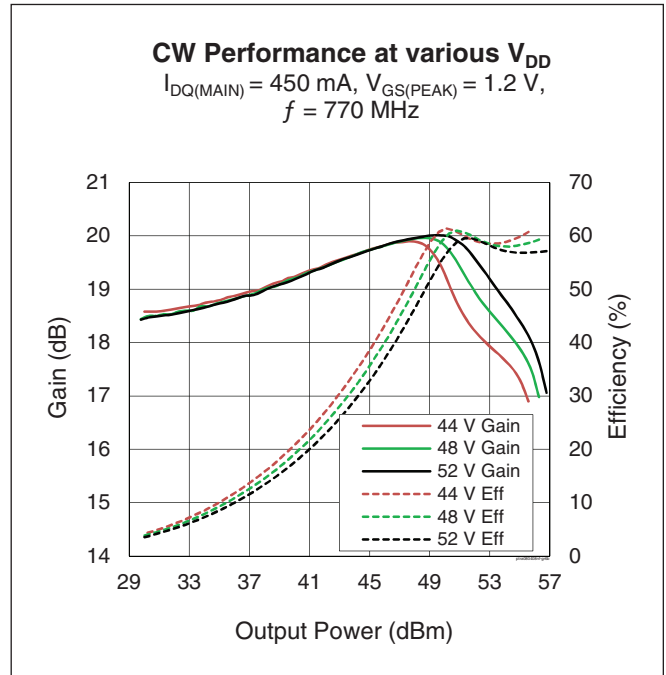
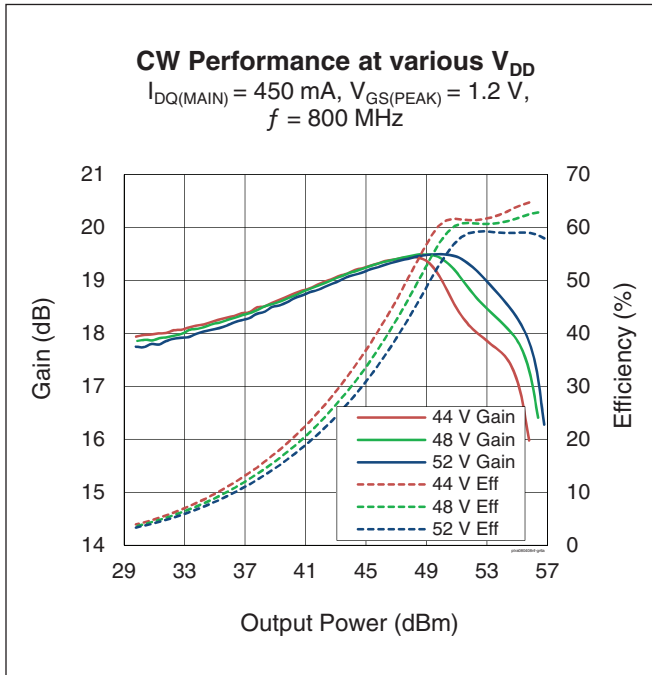



Load Pull Performance

Main side pulsed CW signal: 10 μ sec, 10% duty cycle, $V_{DD} = 48$ V, $I_{DQ} = 390$ mA, class AB

		P _{1dB}									
		Max Output Power					Max Drain Efficiency				
Freq [MHz]	Z _s [Ω]	Z _l [Ω]	Gain [dB]	P _{OUT} [dBm]	P _{OUT} [W]	η_D [%]	Z _l [Ω]	Gain [dB]	P _{OUT} [dBm]	P _{OUT} [W]	η_D [%]
730	2.00 - j3.64	1.96 - j0.96	20.5	53.53	225	56.4	4.71 + j0.66	22.1	51.59	144	66.1
760	2.18 - j4.45	1.97 - j0.37	20.8	53.39	218	58.2	4.83 + j2.41	22.5	50.75	119	67.5
780	2.23 - j4.48	1.75 - j0.81	20.5	53.18	208	52.8	4.95 + j1.41	22.9	51.00	126	66.9
805	2.91 - j5.23	1.75 - j0.81	20.7	53.23	210	54.1	3.29 + j1.34	22.4	51.59	144	67.4
820	2.96 - j5.44	1.96 - j0.96	21.2	53.12	205	55.8	3.43 + j0.83	22.7	51.79	151	67.6

		P _{3dB}									
		Max Output Power					Max Drain Efficiency				
Freq [MHz]	Z _s [Ω]	Z _l [Ω]	Gain [dB]	P _{OUT} [dBm]	P _{OUT} [W]	η_D [%]	Z _l [Ω]	Gain [dB]	P _{OUT} [dBm]	P _{OUT} [W]	η_D [%]
730	2.00 - j3.64	1.96 - j0.96	18.5	54.48	281	60.9	5.35 + j1.53	20.2	51.79	151	67.9
760	2.18 - j4.45	2.00 - j0.39	18.8	54.23	265	62.2	4.77 + j1.31	20.5	52.01	159	69.6
780	2.23 - j4.48	1.56 - j1.27	18.2	54.11	258	53.7	4.29 + j1.74	20.6	51.82	152	69.3
805	2.91 - j5.23	1.99 - j0.95	19.0	54.06	255	59.4	3.29 + j1.34	20.4	52.24	167	69.2
820	2.96 - j5.44	1.99 - j1.26	19.2	53.99	251	58.1	3.60 + j1.21	20.8	52.16	164	69.8

Peak side pulsed CW signal: 10 μ sec, 10% duty cycle, $V_{DD} = 48$ V, $V_{GS_{PK}} = 2.2$ V, class C

		P _{1dB}									
		Max Output Power					Max Drain Efficiency				
Freq [MHz]	Z _s [Ω]	Z _l [Ω]	Gain [dB]	P _{OUT} [dBm]	P _{OUT} [W]	η_D [%]	Z _l [Ω]	Gain [dB]	P _{OUT} [dBm]	P _{OUT} [W]	η_D [%]
730	1.79 - j3.78	1.06 - j0.36	17.2	55.63	366	63.4	1.16 + j1.09	18.1	52.87	194	78.4
760	2.22 - j4.57	1.05 - j0.36	17.2	55.58	361	64.3	0.87 + j0.93	18.2	52.54	179	77.8
780	2.24 - j4.52	1.14 - j0.55	17.1	55.52	356	62.0	0.89 + j0.86	18.2	52.45	176	76.4
805	2.57 - j5.09	1.33 - j0.81	17.0	55.28	337	61.2	1.30 + j0.58	18.0	53.22	210	74.0
820	3.79 - j5.33	1.13 - j0.67	17.4	55.35	343	62.9	1.10 + j0.75	17.9	52.45	176	74.4

		P _{3dB}									
		Max Output Power					Max Drain Efficiency				
Freq [MHz]	Z _s [Ω]	Z _l [Ω]	Gain [dB]	P _{OUT} [dBm]	P _{OUT} [W]	η_D [%]	Z _l [Ω]	Gain [dB]	P _{OUT} [dBm]	P _{OUT} [W]	η_D [%]
730	1.79 - j3.78	1.06 - j0.36	15.2	56.36	433	65.0	1.12 + j0.79	16.2	54.27	267	77.7
760	2.22 - j4.57	1.33 - j0.44	15.3	56.34	431	68.4	1.42 + j0.90	15.9	54.04	254	76.2
780	2.24 - j4.52	1.16 - j0.62	15.0	56.36	433	64.0	1.31 + j0.54	16.0	54.53	284	75.9
805	2.57 - j5.09	1.34 - j0.81	15.0	56.09	406	63.3	1.39 + j0.47	15.9	54.28	268	74.0
820	3.79 - j5.33	1.21 - j0.71	15.3	56.08	406	64.4	1.25 + j0.46	16.0	54.14	259	74.1



Reference Circuit, tuned for 734 to 821 MHz

Reference Circuit Assembly

DUT	PTRA084808NF V1
Reference Circuit Part No.	LTA/PTRA084808NF-V1
PCB	Rogers 4360, 0.609 mm [0.024"] thick, 2 oz. copper, $\epsilon_r = 6.15$
Find Gerber files for this test fixture on the WolfSpeed Web site at www.wolfspeed.com/RF	

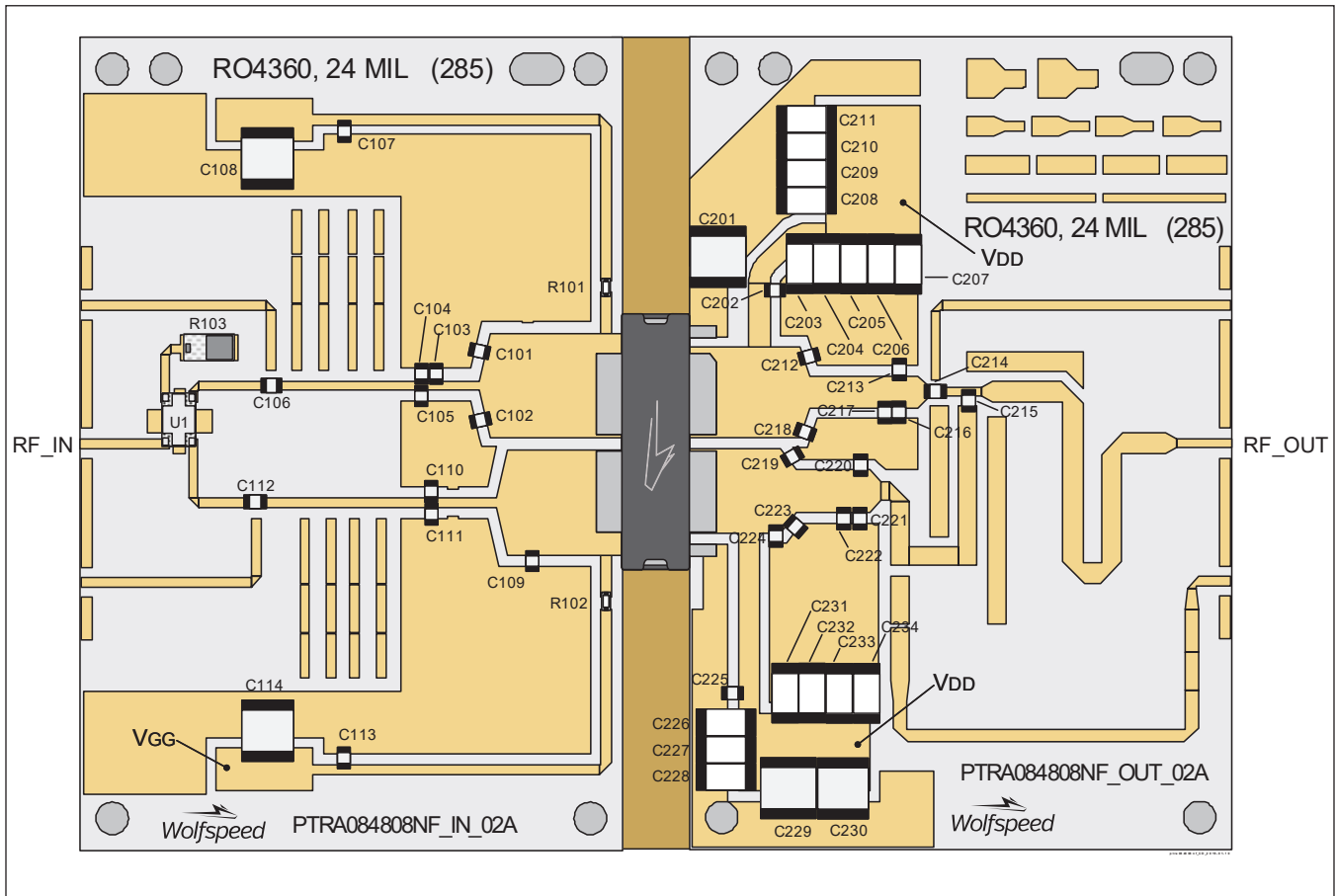

Reference circuit assembly diagram (not to scale)



Reference Circuit (cont.)

Components Information

Component	Description	Manufacturer	P/N
Input			
C101, C102	Capacitor, 2.7 pF	ATC	ATC600F2R7CT250
C103	Capacitor, 1.4 pF	ATC	ATC600F1R4CT250
C104	Capacitor, 3.9 pF	ATC	ATC600F3R9CT250
C105	Capacitor, 1.0 pF	ATC	ATC600F1R0CT250
C106	Capacitor, 68 pF	ATC	ATC600F680JT250
C107, C113	Capacitor, 82 pF	ATC	ATC600F820JT250
C108, C114	Capacitor, 10 μF, 100V	TDK Corporation	C5750X7S2A106M230KB
C109	Capacitor, 5.6 pF	ATC	ATC600F5R6CT250
C110	Capacitor, 4.7 pF	ATC	ATC600F4R7CT250
C111	Capacitor, 2.0 pF	ATC	ATC600F2R0CT250
C112	Capacitor, 56 pF	ATC	ATC800A560JT250
R101, R102	Resistor, 10 ohms	Panasonic Electronic Components	ERJ-8GEYJ100V
R103	Resistor, 50 ohms	Anaren	C8A50Z4A
U1	Hybrid coupler	Anaren	X3C07F1-02S
Output			
C201, C203, C204, C205, C206, C207, C208, C209, C210, C211, C226, C227, C228, C229, C230, C231, C232, C233, C234	Capacitor, 10 μF, 100V	TDK Corporation	C5750X7S2A106M230KB
C202, C212, C215	Capacitor, 82 pF	ATC	ATC600F820JT250
C213	Capacitor, 6.8 pF	ATC	ATC600F6R8CT250
C214	Capacitor, 47 pF	ATC	ATC600F470JT250
C216, C222	Capacitor, 1.0 pF	ATC	ATC600F1R0CT250
C217	Capacitor, 3.9 pF	ATC	ATC600F3R9CT250
C218	Capacitor, 5.6 pF	ATC	ATC600F5R6CT250
C219, C223	Capacitor, 12 pF	ATC	ATC600F120JT250
C220, C221	Capacitor, 1.5 pF	ATC	ATC600F1R5CT250
C224	Capacitor, 2.0 pF	ATC	ATC600F2R0CT250
C225	Capacitor, 100 pF	ATC	ATC600F101JT250

Pinout Diagram (top view)

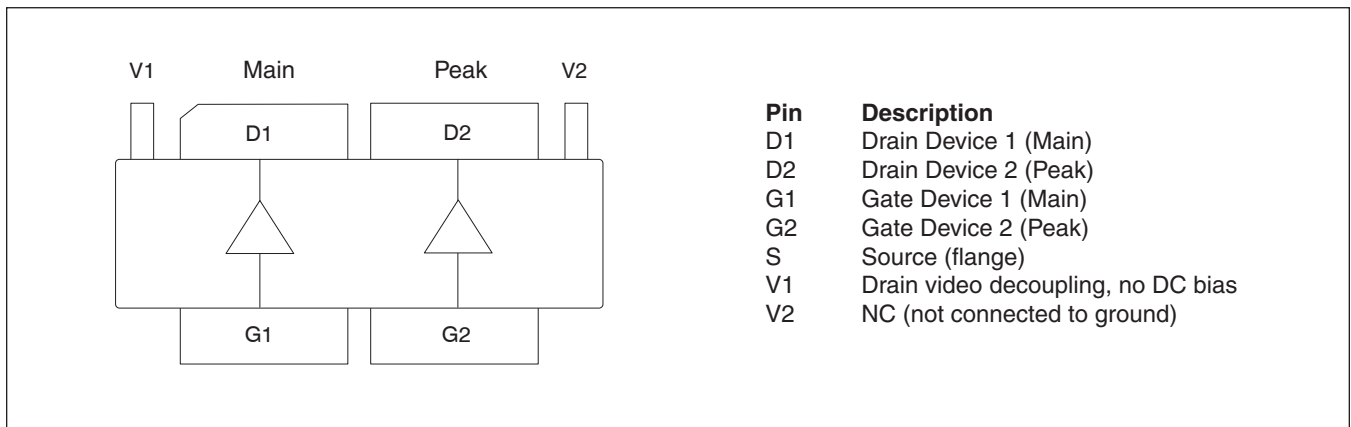

See next page for package mechanical specifications

Package Outline Specifications

Package PG-HBSOF-6-2 (top and side views)

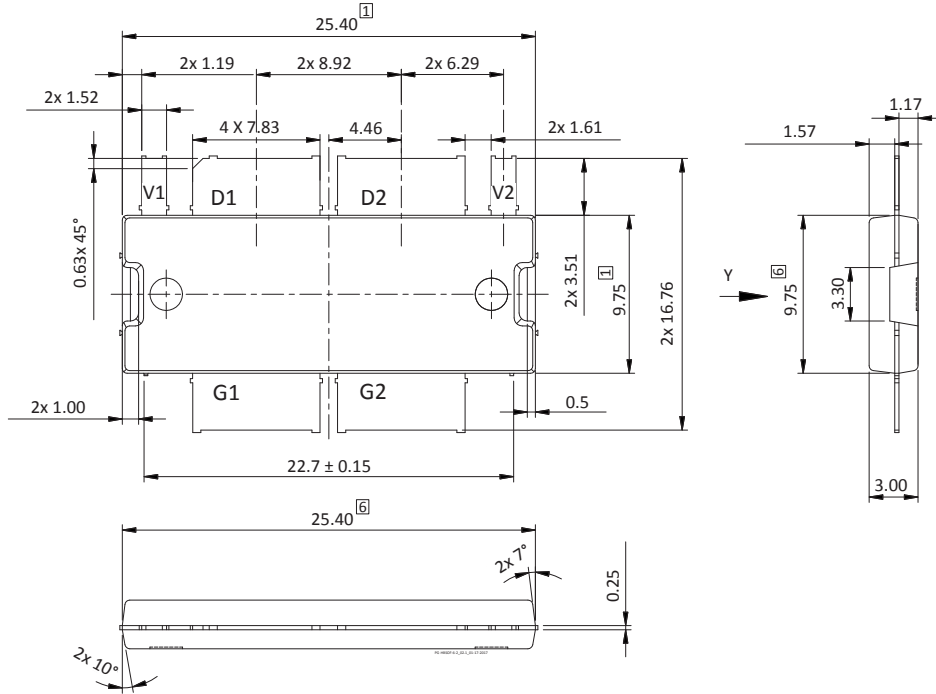

Diagram Notes—unless otherwise specified:

- 1. Mold/dam bar/metal protrusion of 0.30 mm max per side not included.
- 2. Metal protrusions are connected to source and shall not exceed 0.10 mm max.
- 3. Fillets and radii: all radii are 0.3 mm max.
- 4. Interpret dimensions and tolerances per ISO 8015.
- 5. Dimensions are mm.
- 6. Does not include mold/dam bar and metal protrusion.
- 7. Exposed metal surface is tin-plated, may not be covered by mold compound.
- 8. All tolerances ± 0.1 mm unless specified otherwise.
- 9. All metal surfaces are tin-plated, except area of cut.
- 10. Lead thickness: 0.25 mm.
- 11. Pins: D1, D2 = drain; G1, G2 = gate; S = source, V1, V2 = no DC bias, NC or connect to GRD

Package Outline Specifications

Package PG-HBSOF-6-2 (bottom view)

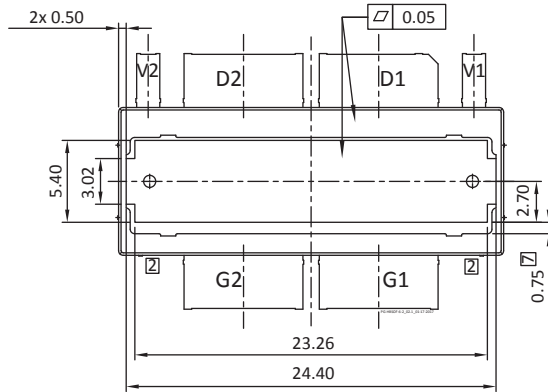

Diagram Notes—unless otherwise specified:

- 1. Mold/dam bar/metal protrusion of 0.30 mm max per side not included.
- 2. Metal protrusions are connected to source and shall not exceed 0.10 mm max.
- 3. Fillets and radii: all radii are 0.3 mm max.
- 4. Interpret dimensions and tolerances per ISO 8015.
- 5. Dimensions are mm.
- 6. Does not include mold/dam bar and metal protrusion.
- 7. Exposed metal surface is tin-plated, may not be covered by mold compound.
- 8. All tolerances ± 0.1 mm unless specified otherwise.
- 9. All metal surfaces are tin-plated, except area of cut.
- 10. Lead thickness: 0.25 mm.
- 11. Pins: D1, D2 = drain; G1, G2 = gate; S = source, V1, V2 = no DC bias, NC or connect to GRD

Revision History

Revision	Date	Data Sheet Type	Page	Subjects (major changes since last revision)
01	2016-09-19	Advance	All	Target specifications shown for product in development
02	2018-03-19	Production	All	Information for production-released product, including firm specifications, operating performance, and reference circuit specifications.
03	2018-06-20	Production	All	Converted to Wolfspeed Data Sheet
03.1	2019-01-10	Production	7	Corrected package in Ref Circuit, updated revision no. due to logo change

For more information, please contact:

4600 Silicon Drive
Durham, North Carolina, USA 27703
www.wolfspeed.com/RF

Sales Contact
RFSales@wolfspeed.com

RF Product Marketing Contact
RFMarketing@wolfspeed.com
919.407.7816

Notes

Disclaimer

Specifications are subject to change without notice. Cree, Inc. believes the information contained within this data sheet to be accurate and reliable. However, no responsibility is assumed by Cree for any infringement of patents or other rights of third parties which may result from its use. No license is granted by implication or otherwise under any patent or patent rights of Cree. Cree makes no warranty, representation or guarantee regarding the suitability of its products for any particular purpose. "Typical" parameters are the average values expected by Cree in large quantities and are provided for information purposes only. These values can and do vary in different applications and actual performance can vary over time. All operating parameters should be validated by customer's technical experts for each application. Cree products are not designed, intended or authorized for use as components in applications intended for surgical implant into the body or to support or sustain life, in applications in which the failure of the Cree product could result in personal injury or death or in applications for planning, construction, maintenance or direct operation of a nuclear facility.