

PTVA084007NF

Thermally-Enhanced High Power RF LDMOS FET 370 W, 48 V, 755 – 805 MHz

Description

The PTVA084007NF is a 370-watt (P_{3dB}) LDMOS FET manufactured with Wolfspeed's 48-V LDMOS process. It is designed for use in multi-standard cellular power amplifier applications. It features a single-ended design and input and output matching that allow for use from 755 MHz to 805 MHz.



PTVA084007NF
Package PG-HBSOF-4-2

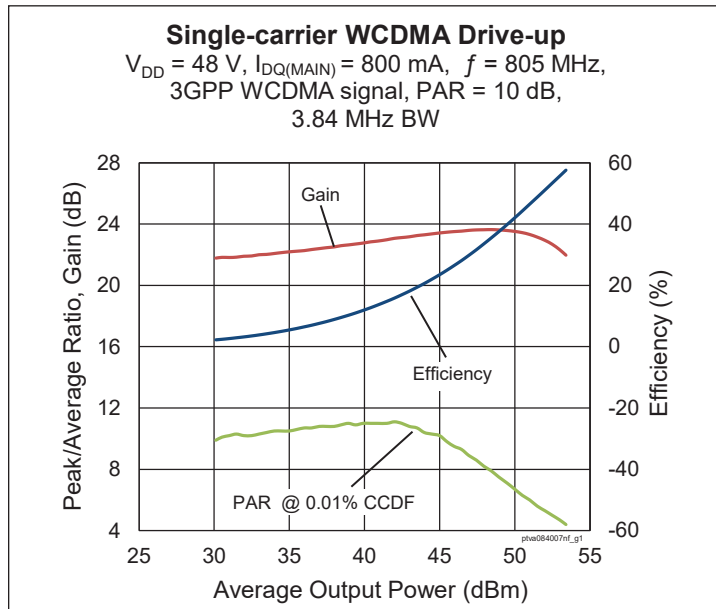

Features

- Broadband internal input and output matching
- Target CW performance, 805 MHz, 48 V, single side
 - Output power at $P_{3dB} = 370\text{ W}$
 - Efficiency = 64%
 - Gain = 20.8 dB
- Capable of handling 10:1 VSWR @ 48 V, 100 W (CW) output power
- Integrated ESD protection
- Human Body Model class 2 (per ANSI/ESDA/ JEDEC JS-001)
- Low thermal resistance
- Pb-free and RoHS compliant

RF Characteristics

Single-carrier WCDMA Specifications (tested in Wolfspeed production test fixture)

$V_{DD} = 48\text{ V}$, $I_{DQ} = 800\text{ mA}$, $P_{OUT} = 80\text{ W avg}$, $f_1 = 805\text{ MHz}$, 3GPP signal, channel bandwidth = 3.84 MHz, peak/average = 10 dB @ 0.01% CCDF.

Characteristic	Symbol	Min	Typ	Max	Unit
Gain	G_{ps}	22	23.6	—	dB
Drain Efficiency	η_D	37	39	—	%
Adjacent Channel Power Ratio	ACPR	—	-31.6	-28.5	dBc
Output PAR @ 0.01% CCDF, 20 MHz	OPAR	6.4	7	—	dB

All published data at $T_{CASE} = 25^\circ\text{C}$ unless otherwise indicated

ESD: Electrostatic discharge sensitive device—observe handling precautions!

DC Characteristics

Characteristic	Conditions	Symbol	Min	Typ	Max	Unit
Drain-Source Breakdown Voltage	$V_{GS} = 0\text{ V}, I_{DS} = 10\text{ mA}$	$V_{(BR)DSS}$	105	—	—	V
Drain Leakage Current	$V_{DS} = 48\text{ V}, V_{GS} = 0\text{ V}$	I_{DSS}	—	—	1	μA
	$V_{DS} = 105\text{ V}, V_{GS} = 0\text{ V}$	I_{DSS}	—	—	10	μA
Gate Leakage Current	$V_{GS} = 10\text{ V}, V_{DS} = 0\text{ V}$	I_{GSS}	—	—	1	μA
On-State Resistance	$V_{GS} = 10\text{ V}, V_{DS} = 0.1\text{ V}$	$R_{DS(on)}$	—	0.12	—	Ω
Operating Gate Voltage	$V_{DS} = 48\text{ V}, I_{DQ} = 0.7\text{ A}$	V_{GS}	3.07	3.67	4.27	V

Maximum Ratings

Parameter	Symbol	Value	Unit
Drain-Source Voltage	V_{DSS}	105	V
Gate-Source Voltage	V_{GS}	-6 to +12	V
Operating Voltage	V_{DD}	0 to +55	V
Junction Temperature	T_J	225	$^{\circ}\text{C}$
Storage Temperature Range	T_{STG}	-65 to +150	$^{\circ}\text{C}$

Thermal Characteristics

Parameter	Symbol	Value	Unit
Thermal Resistance ($T_{CASE} = 70\text{ }^{\circ}\text{C}, 370\text{ W CW}$)	$R_{\theta JC}$	0.21	$^{\circ}\text{C/W}$

Ordering Information

Type and Version	Order Code	Package Description	Shipping
PTVA084007NF V1 R5	PTVA084007NF-V1-R5	PG-HBSOF-4-2, plastic package	Tape & Reel, 500 pcs

Typical RF Performance (data taken in production test fixture)

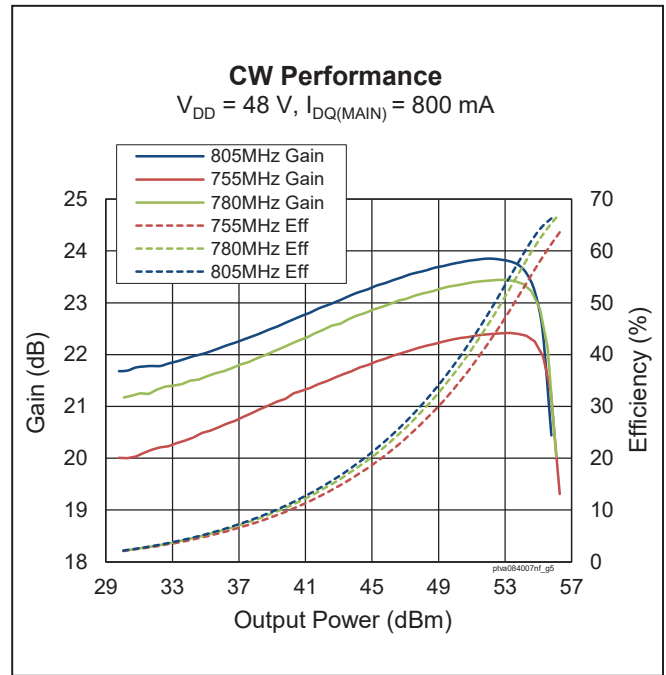
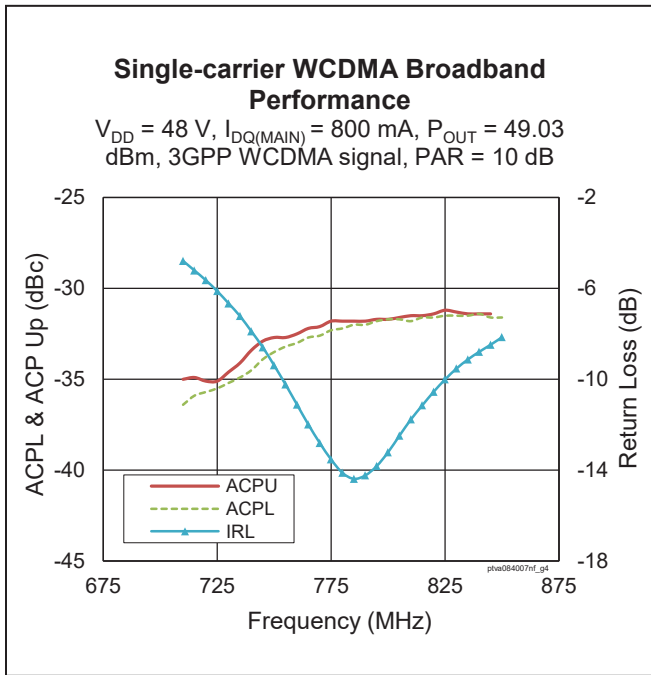
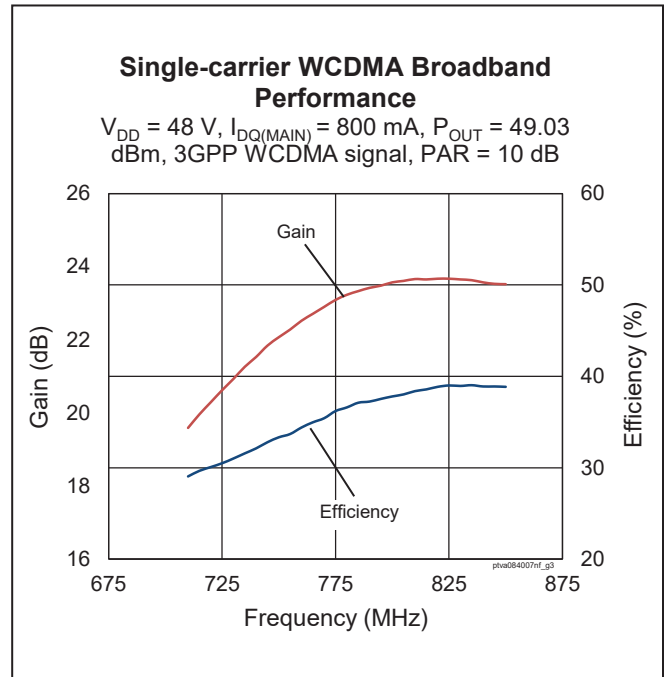
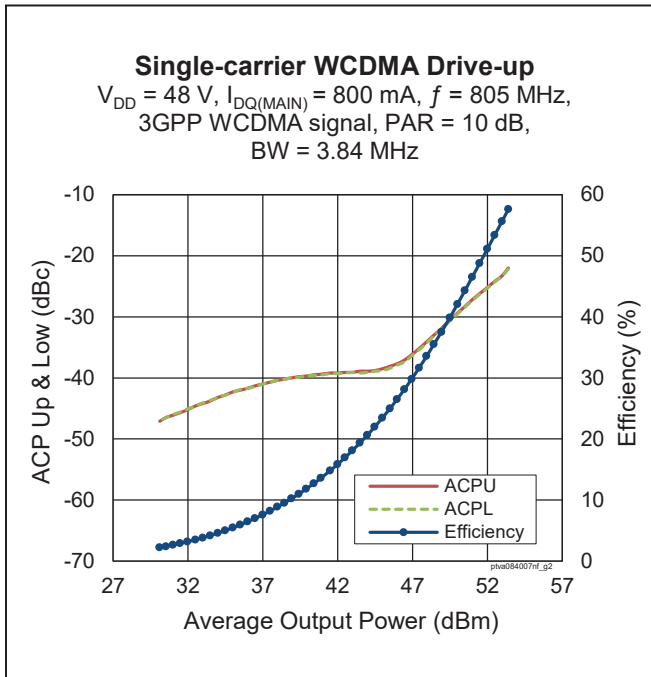



Typical RF Performance (cont.)

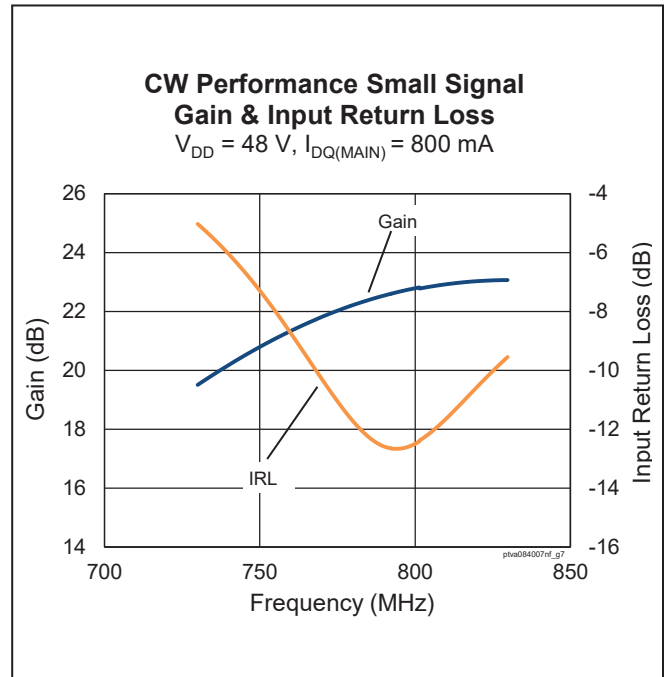
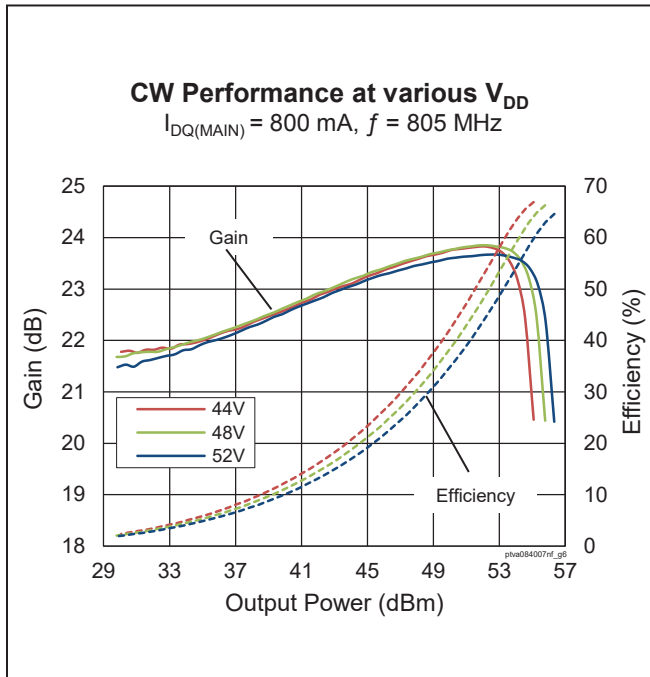

Load Pull Performance

Load Pull Performance – Pulsed CW signal: 160 μs , 10% duty cycle, 48 V, $I_{DQ} = 700 \text{ mA}$

		P_{1dB}									
		Max Output Power					Max Drain Efficiency				
Freq [MHz]	Z _s [Ω]	Z _l [Ω]	Gain [dB]	P _{1dB} [dBm]	P _{1dB} [W]	η_D [%]	Z _l [Ω]	Gain [dB]	P _{1dB} [dBm]	P _{1dB} [W]	η_D [%]
758	1.97-j3.32	1.12-j0.53	21.7	57.00	501.2	58.6	2.02+j0.87	23.4	54.6	287.7	73.2
780	2.23-j3.76	1.09-j0.43	22.0	56.80	478.6	58.3	1.87+j0.89	23.8	54.5	281.2	72.0
803	3.01-j3.64	1.00-j0.42	22.0	56.78	476.4	57.6	1.83+j0.70	23.8	54.6	286.4	71.7

		P_{3dB}									
		Max Output Power					Max Drain Efficiency				
Freq [MHz]	Z _s [Ω]	Z _l [Ω]	Gain [dB]	P _{3dB} [dBm]	P _{3dB} [W]	η_D [%]	Z _l [Ω]	Gain [dB]	P _{3dB} [dBm]	P _{3dB} [W]	η_D [%]
758	1.97-j3.32	1.14-j0.59	19.8	57.75	595.7	61.9	2.00+j0.40	21.3	55.9	388.2	73.8
780	2.23-j3.76	1.09-j0.46	20.0	57.56	570.2	60.9	1.96+j0.43	21.7	55.8	377.6	72.5
803	3.01-j3.64	1.03-j0.49	20.0	57.52	564.9	60.2	1.73+j0.62	21.7	55.3	338.1	72.0

Reference Circuit, 758 – 803 MHz

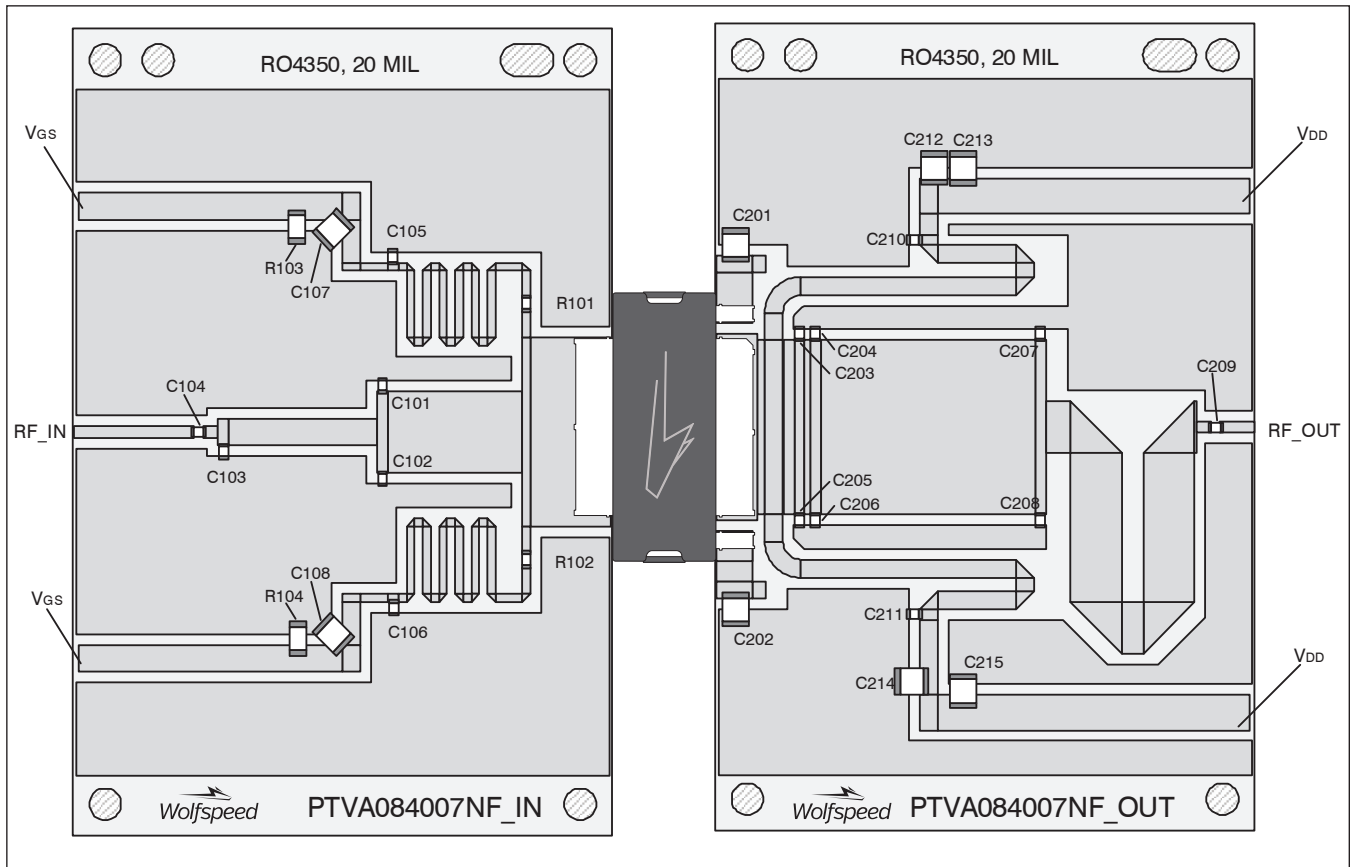

Reference circuit assembly diagram (not to scale)



Reference Circuit (cont.)

Reference Circuit Assembly

DUT	PTVA084007NF V1
Test Fixture Part No.	LTN/PTVA084007NF V1
PCB	Rogers 4350, 0.508 mm [0.020"] thick, 2 oz. copper, $\epsilon_r = 3.66$, $f = 758 - 803$ MHz
Find Gerber files for this test fixture on the Wolfspeed Web site at www.wolfspeed.com/RF	

Components Information

Component	Description	Manufacturer	P/N
Input			
C101, C103	Capacitor, 3.3 pF	ATC	ATC600F3R3CW250T
C102	Capacitor, 4.7 pF	ATC	ATC600F4R7CW250T
C104, C105, C106	Capacitor, 51 pF	ATC	ATC600F510JW250T
C107, C108	Capacitor, 10 μ F	Taiyo Yuden	UMK325C7106MM-T
R101, R102	Resistor, 10 ohms	Panasonic Electronic Components	ERJ-3GEYJ100V
R103, R104	Resistor, 1000 ohms	Panasonic Electronic Components	ERJ-8GEYJ102V
Output			
C201, C202, C212, C213, C214, C215	Capacitor, 10 μ F, 100 V	TDK Corporation	C5750X7S2A106M230KB
C203, C204, C205, C206	Capacitor, 8.2 pF	ATC	ATC600F8R2CW250T
C207, C208	Capacitor, 3.0 pF	ATC	ATC600F3R0CW250T
C209, C210, C211	Capacitor, 51 pF	ATC	ATC600F510JW250T

Pinout Diagram (top view)

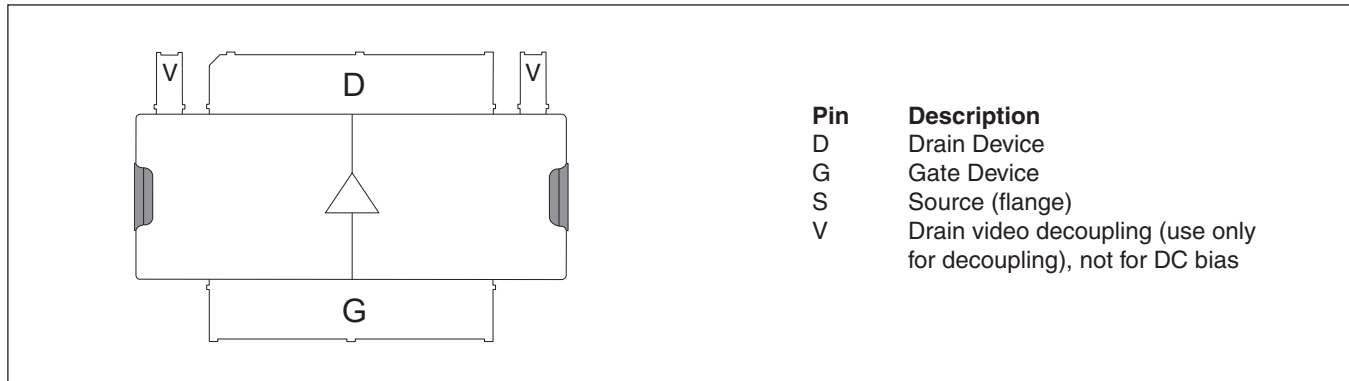

Package Outline Specifications

Package PG-HBSOF-4-2

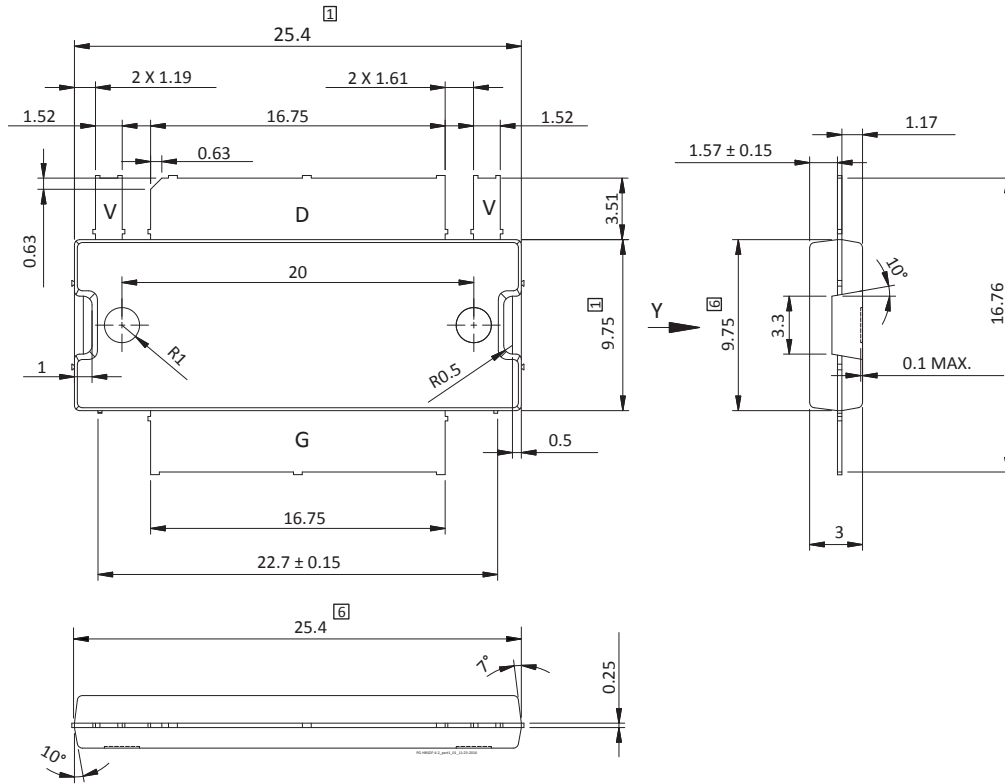

Diagram Notes – unless otherwise specified:

1. Molex/dam bar/metal protrusion of 0.30 mm max per side not included.
2. Metal protrusion are connected to source and shall not exceed 0.10 mm max.
3. Fillets and radii: all radii are 0.3 mm max.
4. Interpret dimensions and tolerances per ISO 8015.
5. Dimensions are mm.
6. Do not include mold/dam bar/metal protrusion.
7. Exposed metal surface is tin-plated, may not be covered by mold compound.
8. All tolerances ± 0.1 mm unless specified otherwise.
9. All metal surfaces are tin-plated, except area of cut.
10. Lead thickness: 0.25 mm.
11. Pins: D = drain; G = gate; S – source; V = drain video decoupling (use only for decoupling), not for DC bias.

Package Outline Specifications

Package PG-HBSOF-4-2

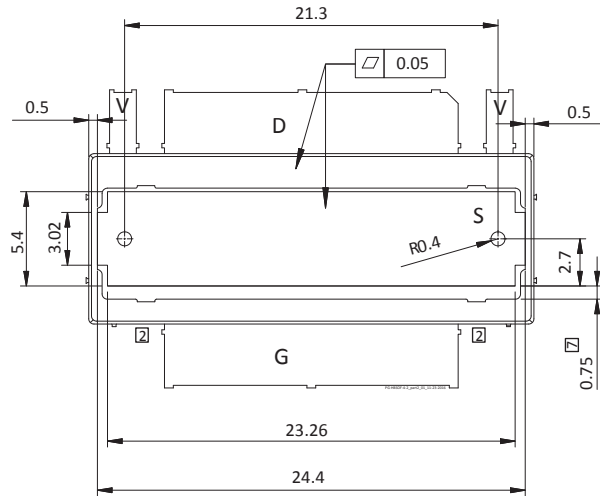

Diagram Notes – unless otherwise specified:

1. Molder/dam bar/metal protrusion of 0.30 mm max per side not included.
2. Metal protrusion are connected to source and shall not exceed 0.10 mm max.
3. Fillets and radii: all radii are 0.3 mm max.
4. Interpret dimensions and tolerances per ISO 8015.
5. Dimensions are mm.
6. Dose not include mold/dam bar/metal protrusion.
7. Exposed metal surface is tin-plated, may not be covered by mold compound.
8. All tolerances ± 0.1 mm unless specified otherwise.
9. All metal surfaces are tin-plated, except area of cut.
10. Lead thickness: 0.25 mm.
11. Pins: D = drain; G = gate; S = source; V = drain video decoupling (use only for decoupling), not for DC bias.

Revision History

Revision	Date	Data Sheet Type	Page	Subjects (major changes since last revision)
01	2016-11-23	Advance	All	Data Sheet reflects advance specification for product development
02	2017-07-06	Preliminary	All	Data Sheet reflects preliminary specification
03	2017-08-30	Production	All	Data Sheet reflects released product specification
04	2018-06-21	Production	All	Converted to Wolfspeed Data Sheet

For more information, please contact:

4600 Silicon Drive
Durham, North Carolina, USA 27703
www.wolfspeed.com/RF

Sales Contact
RFSales@wolfspeed.com

RF Product Marketing Contact
RFMarketing@wolfspeed.com
919.407.7816

Notes

Disclaimer

Specifications are subject to change without notice. Cree, Inc. believes the information contained within this data sheet to be accurate and reliable. However, no responsibility is assumed by Cree for any infringement of patents or other rights of third parties which may result from its use. No license is granted by implication or otherwise under any patent or patent rights of Cree. Cree makes no warranty, representation or guarantee regarding the suitability of its products for any particular purpose. "Typical" parameters are the average values expected by Cree in large quantities and are provided for information purposes only. These values can and do vary in different applications and actual performance can vary over time. All operating parameters should be validated by customer's technical experts for each application. Cree products are not designed, intended or authorized for use as components in applications intended for surgical implant into the body or to support or sustain life, in applications in which the failure of the Cree product could result in personal injury or death or in applications for planning, construction, maintenance or direct operation of a nuclear facility.