

PTFB183404E/F

High Power RF LDMOS Field Effect Transistors 340 W, 1805 – 1880 MHz

Description

The PTFB183404E and PTFB183404F are 340-watt LDMOS FETs intended for use in multi-standard cellular power amplifier applications in the 1805 to 1880 MHz frequency band. Features include input and output matching, high gain and thermally-enhanced package with slotted and earless flanges. Manufactured with Wolfspeed's advanced LDMOS process, these devices provide excellent thermal performance and superior reliability.

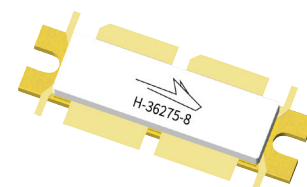

PTFB183404E
Package H-36275-8

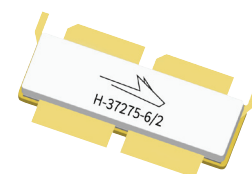

PTFB183404F
Package H-37275-6/2

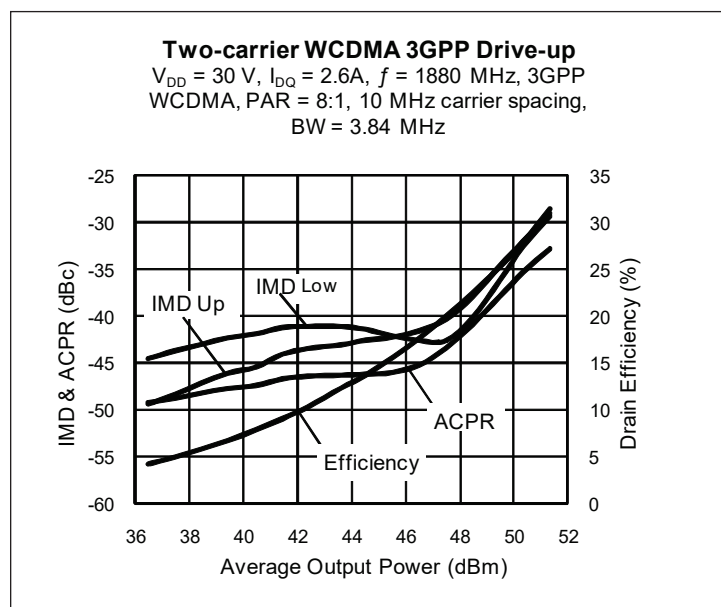

Features

- Broadband internal input and output matching
- Wide video bandwidth
- Typical single-carrier WCDMA performance, 1880 MHz, 30 V
 - Output power = 125 W
 - Efficiency = 31%
 - Gain = 17 dB
 - PAR = 5.5 dB @ 0.01% CCDF probability
 - ACPR @ 5 MHz = -37 dBc
- Increased negative gate-source voltage range for improved performance in Doherty amplifiers
- Capable of handling 10:1 VSWR @ 30 V, 340 W (CW) output power
- Integrated ESD protection
- Excellent thermal stability
- Pb-free and RoHS compliant

RF Characteristics

Two-carrier WCDMA Measurements (tested in Wolfspeed test fixture)

$V_{DD} = 30\text{ V}$, $I_{DQ} = 2.6\text{ A}$, $P_{OUT} = 80\text{ W}$ average, $f_1 = 1870\text{ MHz}$, $f_2 = 1880\text{ MHz}$, 3GPP signal, channel bandwidth = 3.84 MHz, peak/average = 8 dB @ 0.01% CCDF

Characteristic	Symbol	Min	Typ	Max	Unit
Gain	G_{ps}	16	17	—	dB
Drain Efficiency	η_D	24	25.5	—	%
Intermodulation Distortion	IMD	—	-35	-32	dBc

All published data at $T_{CASE} = 25^\circ\text{C}$ unless otherwise indicated

ESD: Electrostatic discharge sensitive device—observe handling precautions!

RF Characteristics (cont.)

Single-carrier WCDMA Performance (not subject to production test – verified by design / characterization in Wolfspeed test fixture)

$V_{DD} = 30\text{ V}$, $I_{DQ} = 2.6\text{ A}$, IQ clipping, channel bandwidth = 3.84 MHz, Input signal PAR = 7.5 dB @ 0.01% CCDF probability

Characteristic	Conditions	Symbol	1805 MHz (Typ)	1842 MHz (Typ)	1880 MHz (Typ)
Gain	$P_{OUT} (AVG) = 49\text{ dBm}$	G_{ps}	17.1	17.3	17.5
	$P_{OUT} (AVG) = 51\text{ dBm}$		17.0	17.15	17.4
Drain Efficiency	$P_{OUT} (AVG) = 49\text{ dBm}$	η_D	25	24.5	24
	$P_{OUT} (AVG) = 51\text{ dBm}$		31	30	30
Output PAR at 0.01%	$P_{OUT} (AVG) = 49\text{ dBm}$	dB	6.5	6.5	6.5
	$P_{OUT} (AVG) = 51\text{ dBm}$		5.5	5.5	5.5
Adjacent Channel Power Ratio	$P_{OUT} (AVG) = 49\text{ dBm}$	ACPR	-43	-42.5	-41
	$P_{OUT} (AVG) = 51\text{ dBm}$		-36	-35	-34

Two-tone Specifications (not subject to production test – verified by design / characterization in Wolfspeed test fixture)

$V_{DD} = 30\text{ V}$, $I_{DQ} = 2.6\text{ A}$, $P_{OUT} = 310\text{ W PEP}$, $f = 1880\text{ MHz}$, tone spacing = 1 MHz

Characteristic	Symbol	Min	Typ	Max	Unit
Gain	G_{ps}	—	17.5	—	dB
Drain Efficiency	η_D	—	35	—	%
Intermodulation Distortion	IMD	—	30	—	dBc

DC Characteristics

Characteristic	Conditions	Symbol	Min	Typ	Max	Unit
Drain-Source Breakdown Voltage	$V_{GS} = 0\text{ V}$, $I_{DS} = 10\text{ mA}$	$V_{(BR)DSS}$	65	—	—	V
Drain Leakage Current	$V_{DS} = 28\text{ V}$, $V_{GS} = 0\text{ V}$	I_{DSS}	—	—	1.0	μA
Drain Leakage Current	$V_{DS} = 63\text{ V}$, $V_{GS} = 0\text{ V}$	I_{DSS}	—	—	10.0	μA
On-State Resistance	$V_{GS} = 10\text{ V}$, $V_{DS} = 0.1\text{ V}$	$R_{DS(on)}$	—	0.05	—	Ω
Operating Gate Voltage	$V_{DS} = 30\text{ V}$, $I_{DQ} = 2.6\text{ A}$	V_{GS}	2.3	2.8	3.3	V
Gate Leakage Current	$V_{GS} = 10\text{ V}$, $V_{DS} = 0\text{ V}$	I_{GSS}	—	—	1.0	μA

Maximum Ratings

Parameter	Symbol	Value	Unit
Drain-Source Voltage	V_{DSS}	65	V
Gate-Source Voltage	V_{GS}	-6 to +10	V
Junction Temperature	T_J	200	°C
Storage Temperature Range	T_{STG}	-40 to +150	°C
Thermal Resistance ($T_{CASE} = 70^\circ\text{C}$, 340 W CW)	$R_{\theta JC}$	0.2	°C/W

Ordering Information

Type and Version	Order Code	Package Description	Shipping
PTFB183404E V1 R0	PTFB183404E-V1-R0	Slotted push-pull	Tape & Reel, 50pcs
PTFB183404E V1 R250	PTFB183404E-V1-R250	Slotted push-pull	Tape & Reel, 250pcs
PTFB183404F V2 R0	PTFB183404F-V2-R0	Earless push-pull	Tape & Reel, 50pcs
PTFB183404F V2 R250	PTFB183404F-V2-R250	Earless push-pull	Tape & Reel, 250pcs

Typical Performance (data taken in a production test fixture)

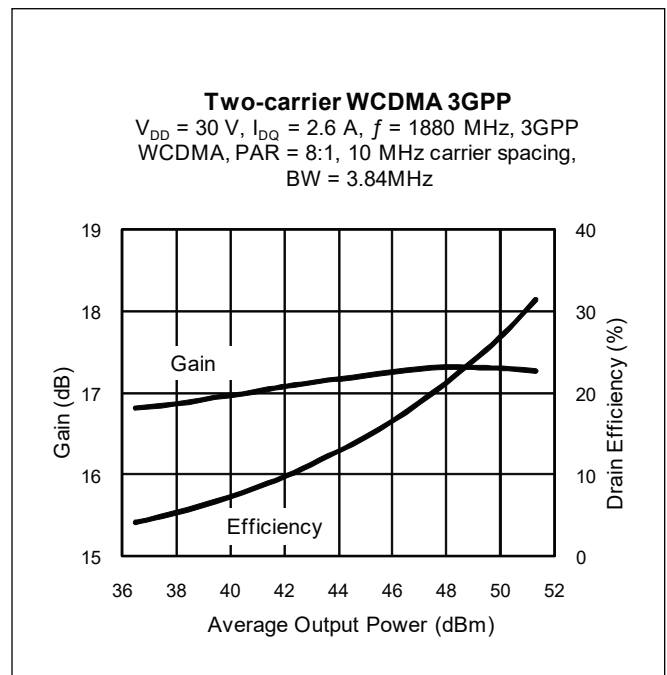
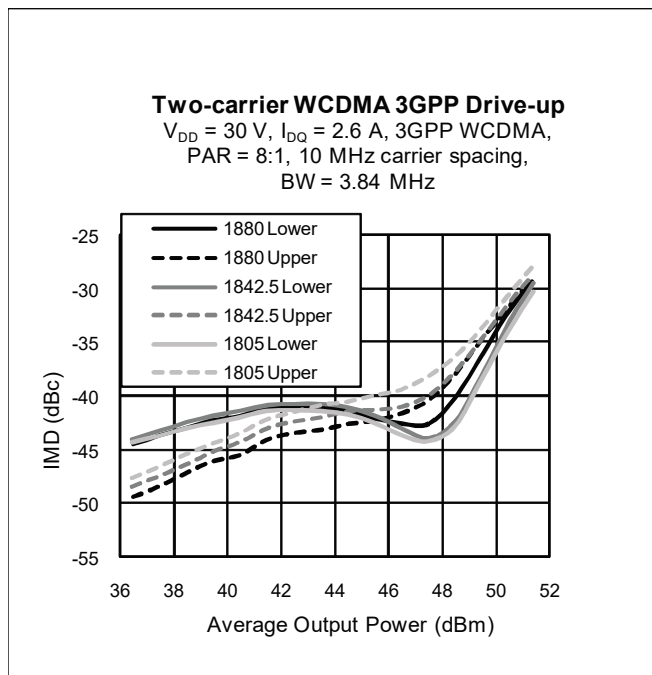



Typical Performance (cont.)

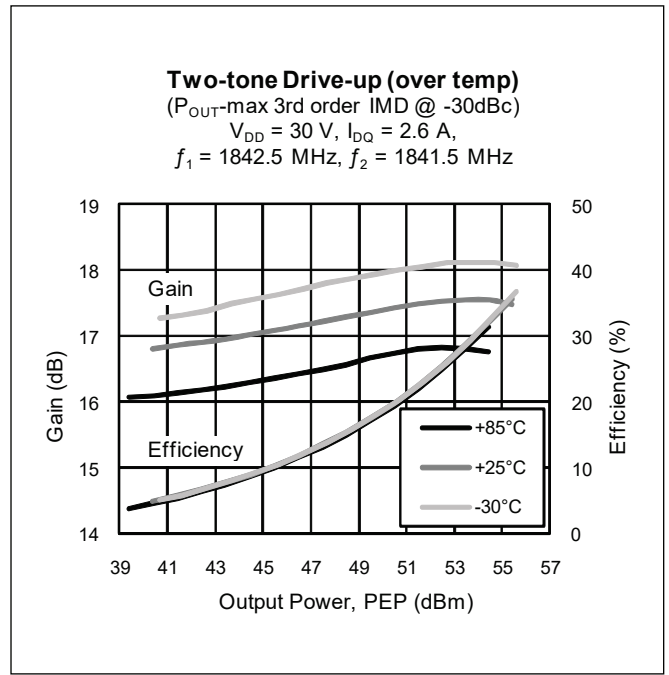
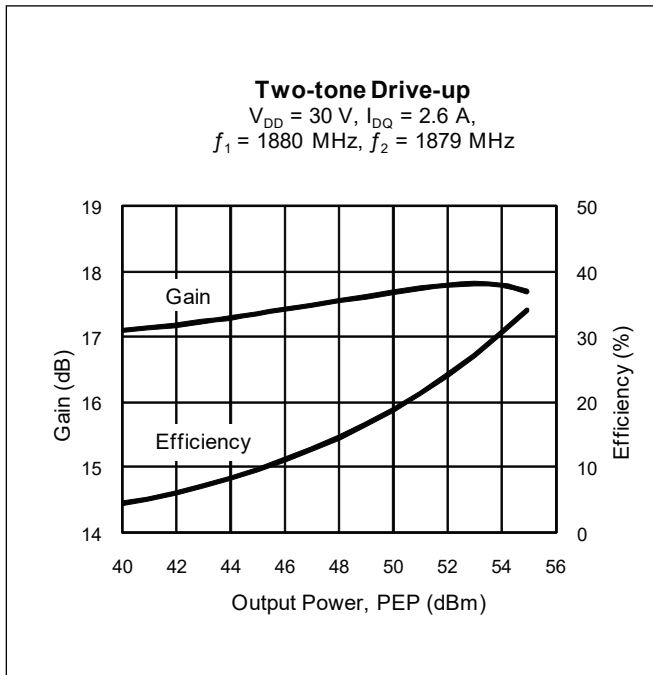
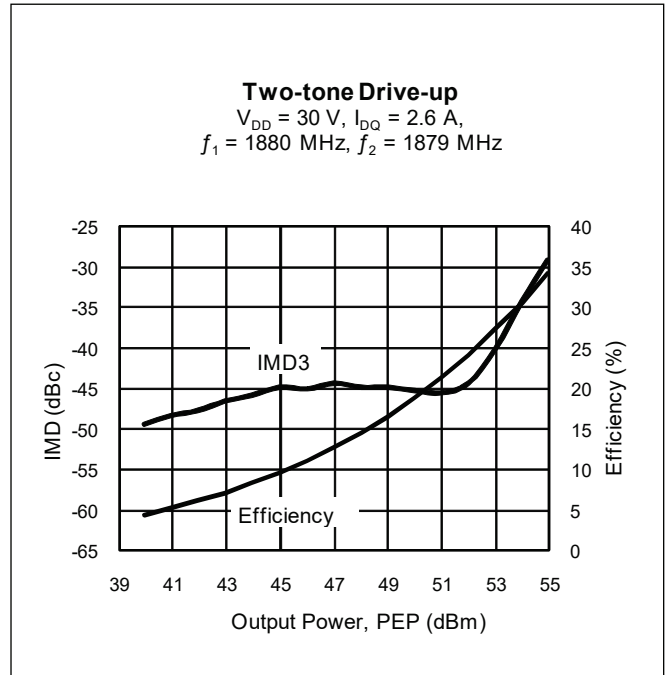
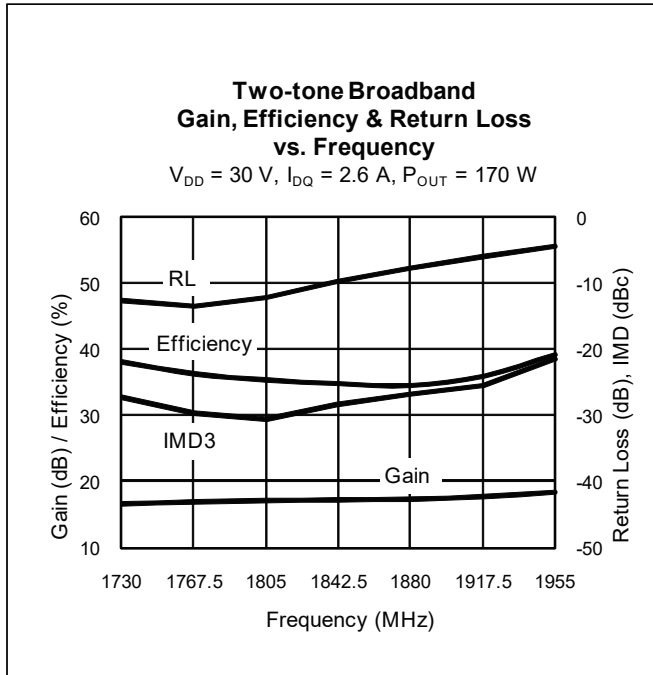



Typical Performance (cont.)

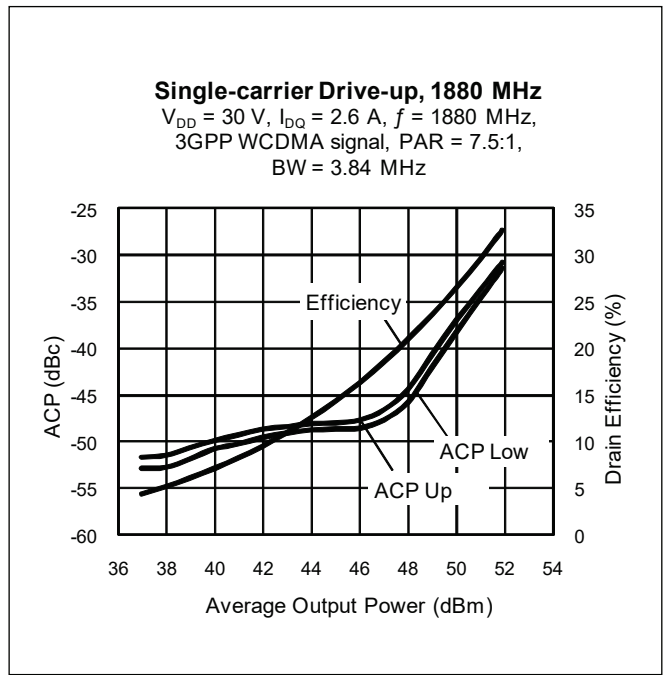
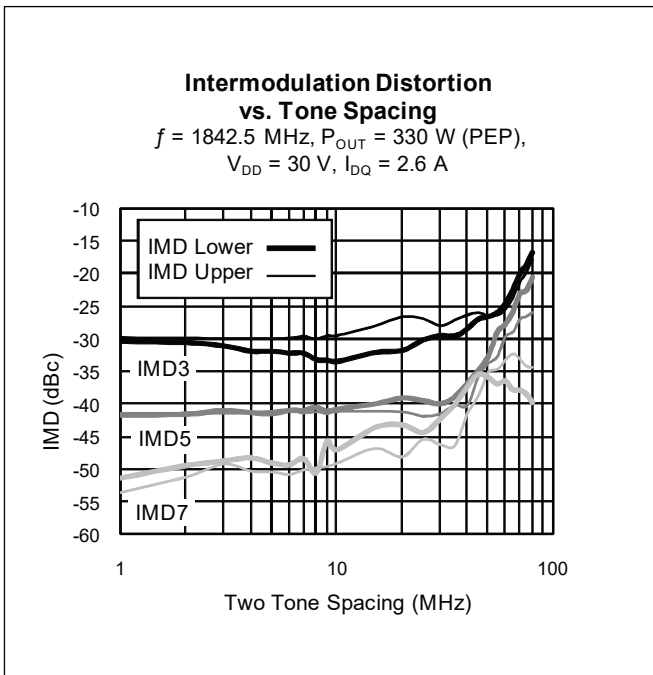
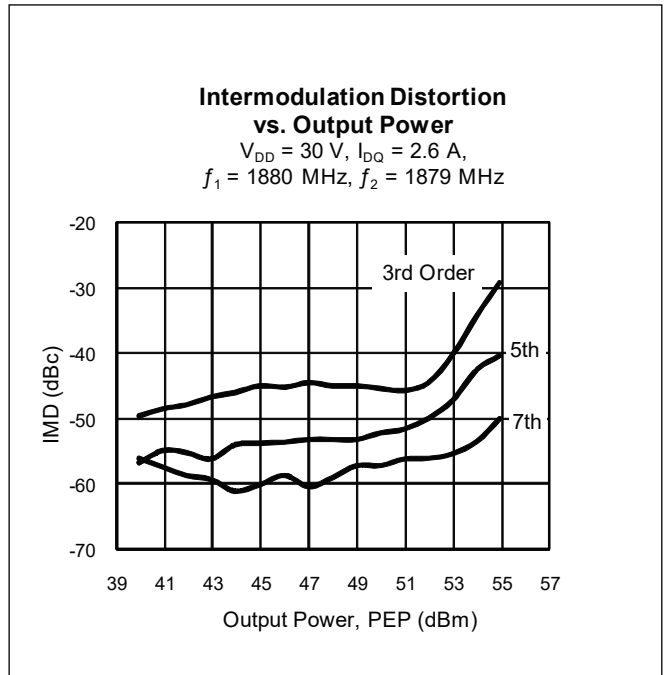
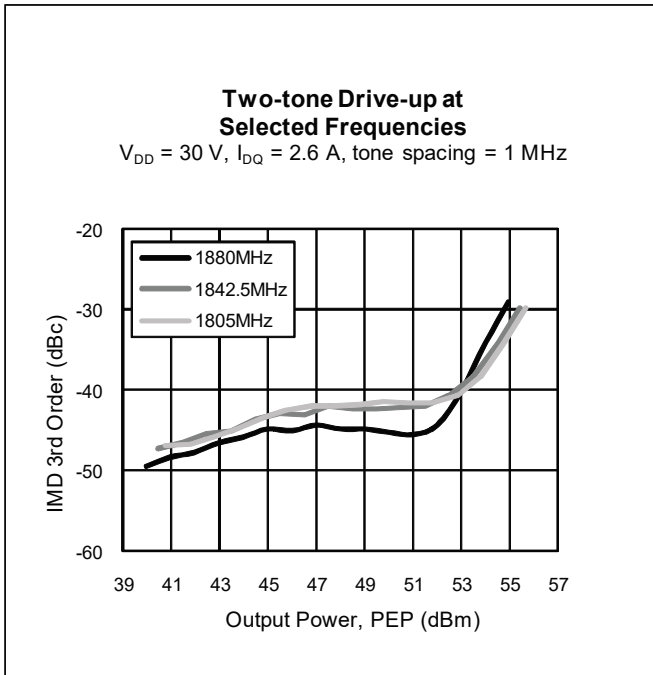



Typical Performance (cont.)

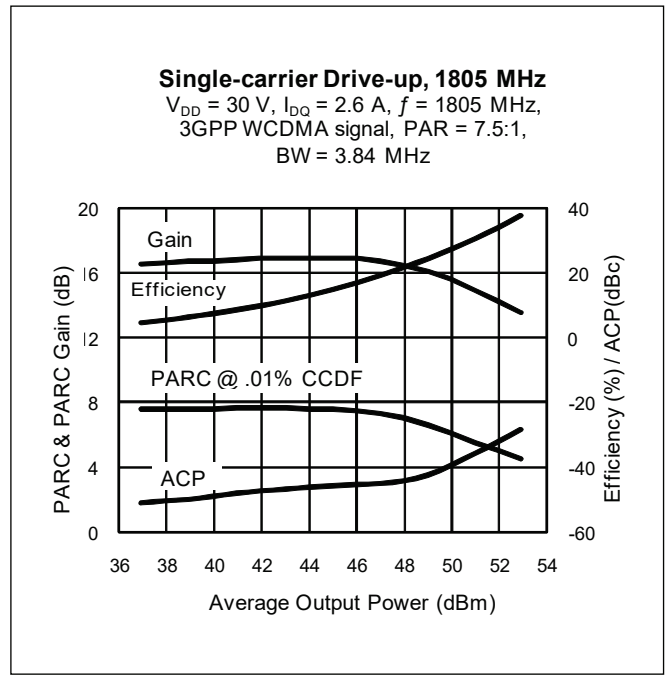
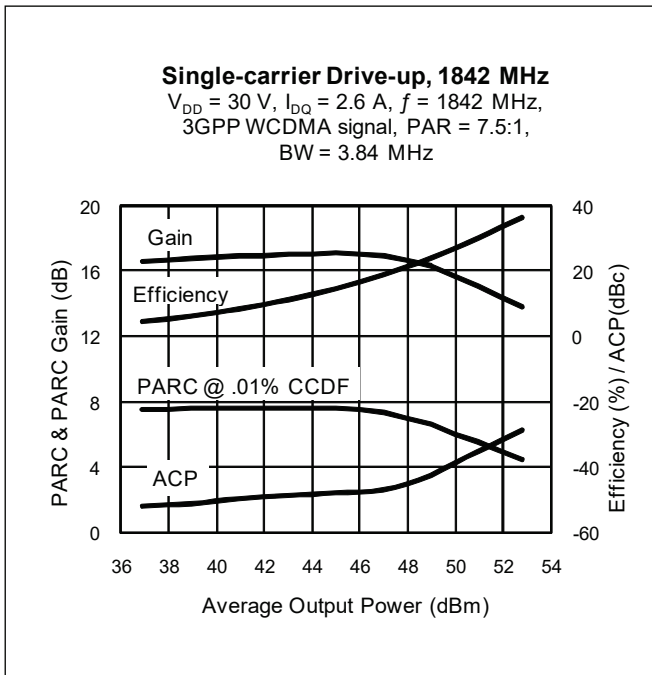
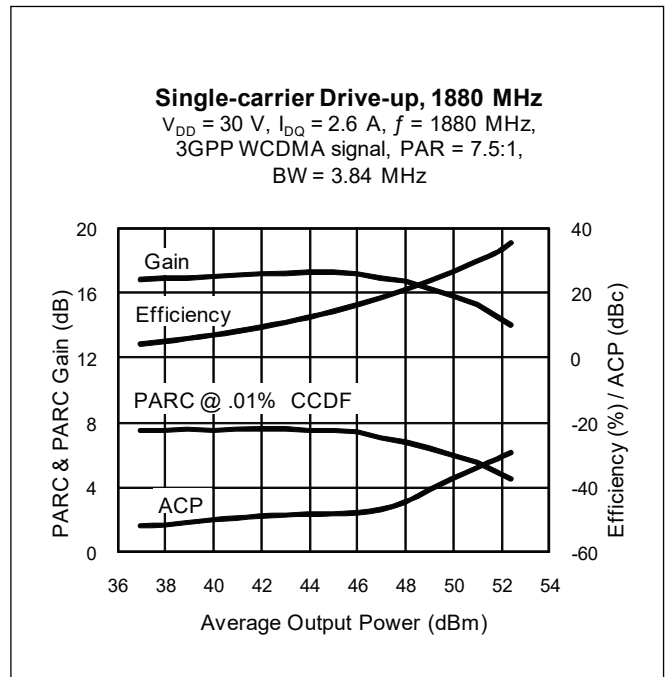
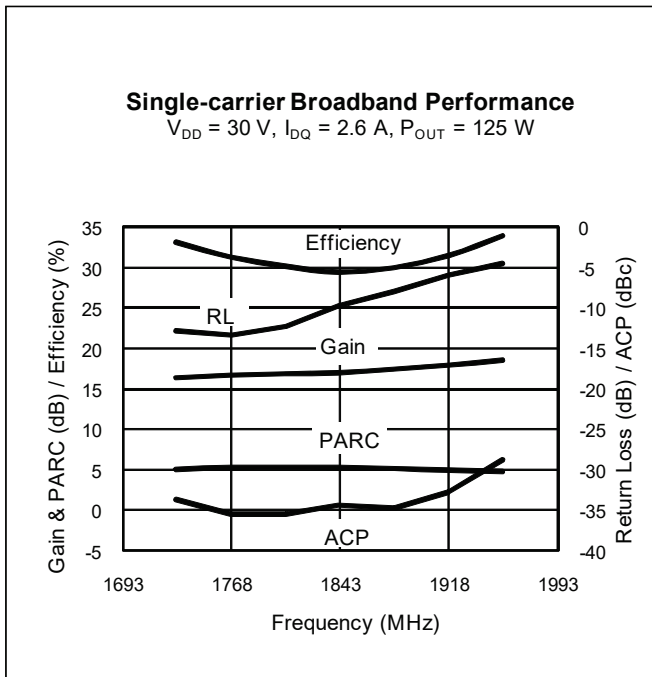

Broadband Circuit Impedance (combined leads)

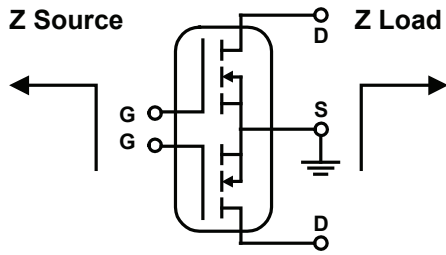

Frequency MHz	Z Source Ω		Z Load Ω	
	R	jX	R	jX
1730	1.86	-4.25	0.55	-2.78
1768	1.77	-4.06	0.54	-2.66
1805	1.68	-3.88	0.53	-7.54
1843	1.61	-3.70	0.52	-2.43
1880	1.56	-3.53	0.51	-2.32
1918	1.51	-3.37	0.51	-2.21
1955	1.47	-3.22	0.5	-2.11

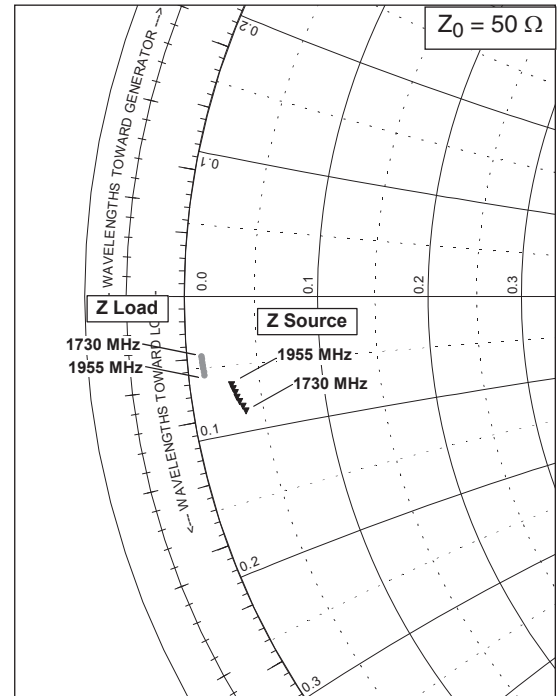

See next page for reference circuit information



Reference Circuit

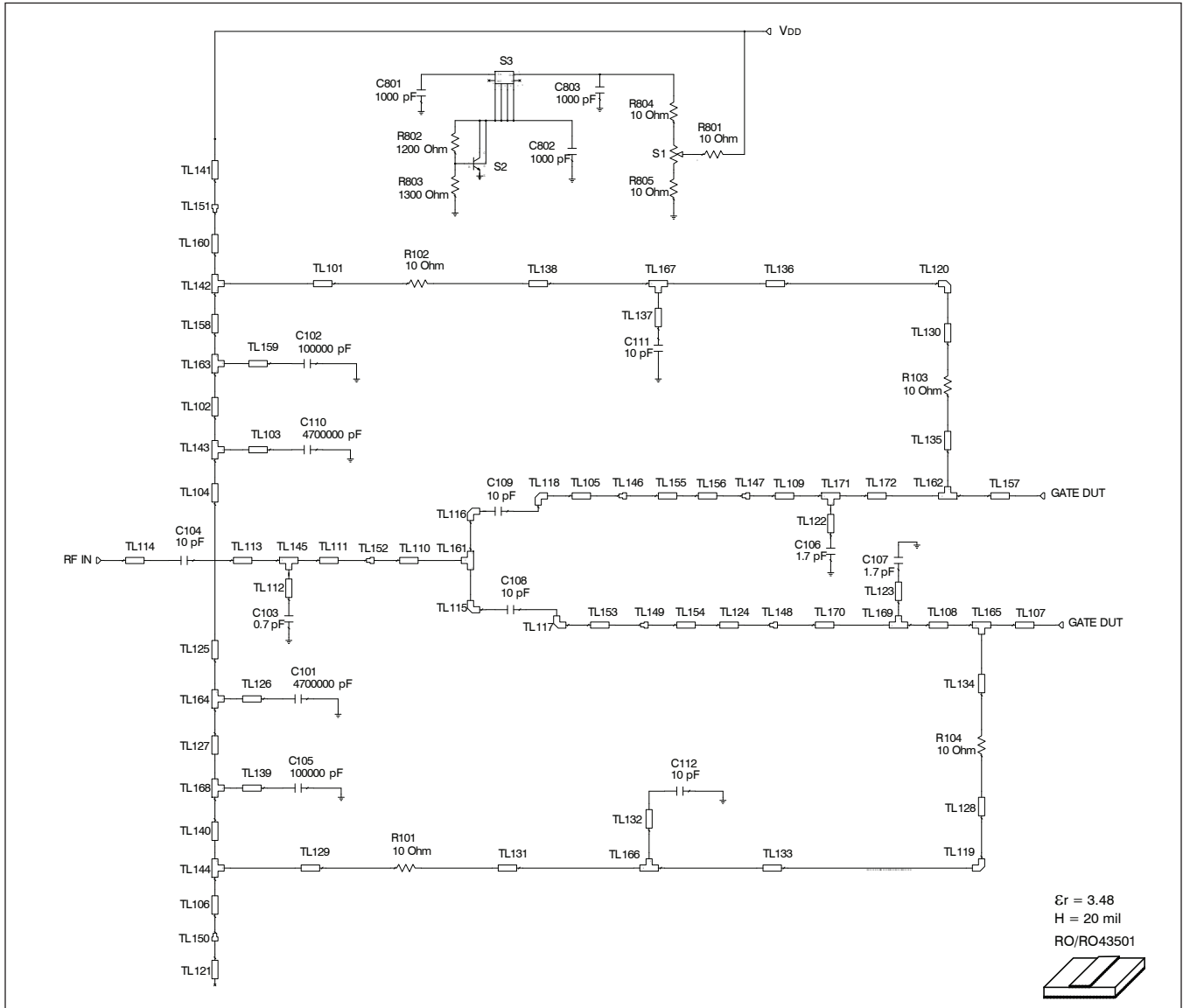

Reference circuit input schematic for $f = 1880$ MHz

Reference Circuit (cont.)

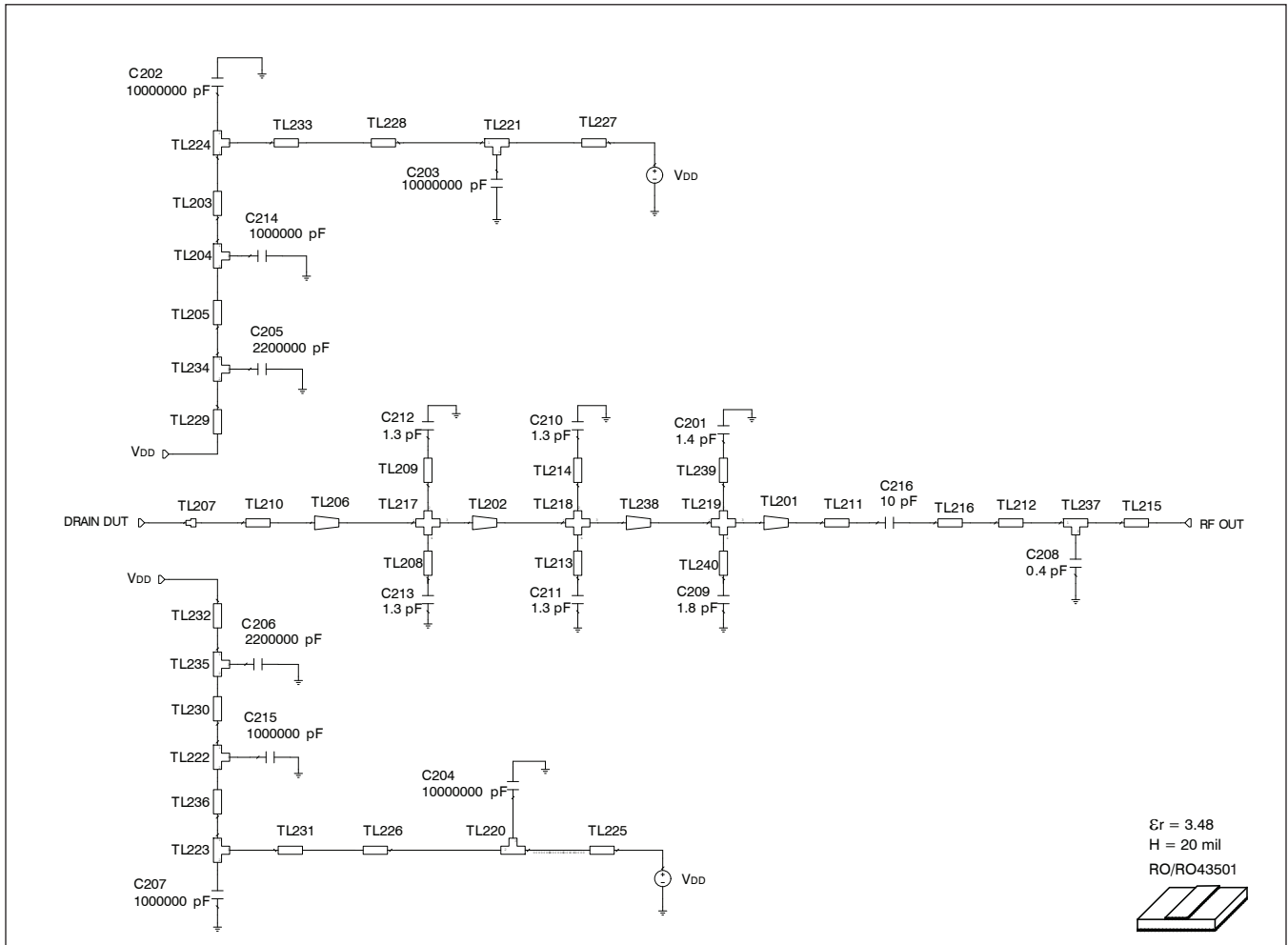

Reference circuit output schematic for $f = 1880$ MHz

Reference Circuit (cont.)

Description	
DUT	PTFB183404EF
PCB	0.508 mm [.020"] thick, $\epsilon_r = 3.48$, Rogers 4350, 1 oz. copper

Electrical Characteristics at 1880 MHz

Transmission Line	Electrical Characteristics	Dimensions: mm	Dimensions: mils
Input			
TL101, TL129	0.017 λ , 54.17 Ω	W = 1.016, L = 1.651	W = 40, L = 65
TL102	0.002 λ , 63.89 Ω	W = 0.762, L = 0.203	W = 30, L = 8
TL103, TL139	0.000 λ , 41.75 Ω	W = 1.524, L = 0.025	W = 60, L = 1
TL104	0.208 λ , 63.89 Ω	W = 0.762, L = 20.297	W = 30, L = 799
TL105	0.008 λ , 28.85 Ω	W = 2.540, L = 0.762	W = 100, L = 30
TL106	0.005 λ , 63.89 Ω	W = 0.762, L = 0.508	W = 30, L = 20
TL107, TL157	0.061 λ , 8.03 Ω	W = 11.430, L = 5.359	W = 450, L = 211
TL108, TL172	0.004 λ , 8.03 Ω	W = 11.430, L = 0.338	W = 450, L = 13
TL109, TL170	0.002 λ , 8.03 Ω	W = 11.430, L = 0.196	W = 450, L = 8
TL110	0.022 λ , 32.60 Ω	W = 2.159, L = 2.032	W = 85, L = 80
TL111	0.028 λ , 49.69 Ω	W = 1.168, L = 2.710	W = 46, L = 107
TL112	0.000 λ , 63.89 Ω	W = 0.762, L = 0.025	W = 30, L = 1
TL113	0.016 λ , 49.69 Ω	W = 1.168, L = 1.549	W = 46, L = 61
TL114	0.029 λ , 49.69 Ω	W = 1.168, L = 2.743	W = 46, L = 108
TL115, TL116, TL117, TL118		W = 2.540	W = 100
TL119, TL120		W = 1.016	W = 40
TL121, TL141	0.013 λ , 34.08 Ω	W = 2.032, L = 1.270	W = 80, L = 50
TL122, TL123	0.000 λ , 63.89 Ω	W = 0.762, L = 0.000	W = 30, L = 0
TL124, TL156	0.014 λ , 17.20 Ω	W = 4.826, L = 1.270	W = 190, L = 50
TL125	0.013 λ , 63.89 Ω	W = 0.762, L = 1.270	W = 30, L = 50
TL126, TL139, TL159	0.000 λ , 41.75 Ω	W = 1.524, L = 0.025	W = 60, L = 1
TL127	0.002 λ , 63.89 Ω	W = 0.762, L = 0.203	W = 30, L = 8
TL128, TL130	0.013 λ , 54.17 Ω	W = 1.016, L = 1.262	W = 40, L = 50
TL131, TL138	0.014 λ , 54.17 Ω	W = 1.016, L = 1.397	W = 40, L = 55
TL132, TL137	0.000 λ , 34.08 Ω	W = 2.032, L = 0.025	W = 80, L = 1
TL133, TL136	0.079 λ , 54.17 Ω	W = 1.016, L = 7.620	W = 40, L = 300
TL134, TL135	0.008 λ , 54.17 Ω	W = 1.016, L = 0.762	W = 40, L = 30
TL140	0.015 λ , 63.89 Ω	W = 0.762, L = 1.422	W = 30, L = 56
TL142, TL144	0.010 λ , 63.89 Ω	W1 = 0.762, W2 = 0.762, W3 = 1.016	W1 = 30, W2 = 30, W3 = 40
TL143, TL168	0.016 λ , 63.89 Ω	W1 = 0.762, W2 = 0.762, W3 = 1.524	W1 = 30, W2 = 30, W3 = 60
TL145	0.008 λ , 49.69 Ω	W1 = 1.168, W2 = 1.168, W3 = 0.762	W1 = 46, W2 = 46, W3 = 30
TL146		W1 = 0.003, W2 = 0.005, Offset = 0.000	W1 = 3, W2 = 190, Offset = 10
TL147		W1 = 0.005, W2 = 0.011, Offset = 0.003	W1 = 5, W2 = 450, Offset = 130

table continued on page 11

Reference Circuit (cont.)**Electrical Characteristics at 1880 MHz**

Transmission Line	Electrical Characteristics	Dimensions: mm	Dimensions: mils
Input			
TL148		W1 = 0.005, W2 = 0.011, Offset = -0.003	W1 = 5, W2 = 450, Offset = -130
TL149		W1 = 0.003, W2 = 0.005, Offset = 0.000	W1 = 3, W2 = 190, Offset = -10
TL150		W1 = 2.032, W2 = 0.762	W1 = 80, W2 = 30
TL151		W1 = 2.540, W2 = 0.762	W1 = 100, W2 = 30
TL152		W1 = 1.168, W2 = 2.159	W1 = 46, W2 = 85
TL153	0.008 λ , 28.85 Ω	W = 2.540, L = 0.762	W = 100, L = 30
TL154, TL155	0.006 λ , 17.20 Ω	W = 4.826, L = 0.508	W = 190, L = 20
TL158	0.015 λ , 63.89 Ω	W = 0.762, L = 1.422	W = 30, L = 56
TL160	0.004 λ , 63.89 Ω	W = 0.762, L = 0.404	W = 30, L = 16
TL161	0.023 λ , 28.85 Ω	W1 = 2.540, W2 = 2.540, W3 = 2.159	W1 = 100, W2 = 100, W3 = 85
TL162, TL165	0.011 λ , 8.03 Ω	W1 = 11.430, W2 = 11.430, W3 = 1.016	W1 = 450, W2 = 450, W3 = 40
TL163, TL164	0.016 λ , 63.89 Ω	W1 = 0.762, W2 = 0.762, W3 = 1.524	W1 = 30, W2 = 30, W3 = 60
TL166, TL167	0.021 λ , 54.17 Ω	W1 = 1.016, W2 = 1.016, W3 = 2.032	W1 = 40, W2 = 40, W3 = 80
TL169, TL171	0.009 λ , 8.03 Ω	W1 = 11.430, W2 = 11.430, W3 = 0.762	W1 = 450, W2 = 450, W3 = 30

See next page for more reference circuit information

Reference Circuit (cont.)

Electrical Characteristics at 1880 MHz

Transmission Line	Electrical Characteristics	Dimensions: mm	Dimensions: mils
Output			
TL201 (taper)	0.011 λ , 12.30 Ω / 34.72 Ω	W1 = 7.112, W2 = 1.981, L = 1.016	W1 = 280, W2 = 78, L = 40
TL202 (taper)	0.009 λ , 5.88 Ω / 7.95 Ω	W1 = 16.002, W2 = 11.557, L = 0.762	W1 = 630, W2 = 455, L = 30
TL203	0.019 λ , 20.93 Ω	W = 3.810, L = 1.778	W = 150, L = 70
TL204	0.019 λ , 20.93 Ω	W1 = 3.810, W2 = 3.810, W3 = 1.778	W1 = 150, W2 = 150, W3 = 70
TL205, TL230	0.003 λ , 20.93 Ω	W = 3.810, L = 0.254	W = 150, L = 10
TL206 (taper)	0.023 λ , 3.67 Ω / 5.88 Ω	W1 = 26.365, W2 = 16.002, L = 2.032	W1 = 1038, W2 = 630, L = 80
TL207		W1 = 25.400, W2 = 26.365	W1 = 1000, W2 = 1038
TL208, TL209	0.000 λ , 144.35 Ω	W = 0.025, L = 0.025	W = 1, L = 1
TL210	0.055 λ , 3.67 Ω	W = 26.365, L = 4.801	W = 1038, L = 189
TL211	0.044 λ , 34.72 Ω	W = 1.981, L = 4.115	W = 78, L = 162
TL212	0.005 λ , 47.12 Ω	W = 1.270, L = 0.432	W = 50, L = 17
TL213, TL214, TL239, TL240	0.000 λ , 144.35 Ω	W = 0.025, L = 0.025	W = 1, L = 1
TL215	0.066 λ , 47.12 Ω	W = 1.270, L = 6.299	W = 50, L = 248
TL216	0.014 λ , 28.85 Ω	W = 2.540, L = 1.270	W = 100, L = 50
TL217		W1 = 16.002, W2 = 0.025, W3 = 16.002 W4 = 0.025	W1 = 630, W2 = 1, W3 = 630, W4 = 1
TL218		W1 = 11.557, W2 = 0.025, W3 = 11.557 W4 = 0.025	W1 = 455, W2 = 1, W3 = 455, W4 = 1
TL219		W1 = 7.112, W2 = 0.025, W3 = 7.112 W4 = 0.025	W1 = 280, W2 = 1, W3 = 280 W4 = 1
TL220, TL221, TL223, TL224	0.042 λ , 20.93 Ω	W1 = 3.810, W2 = 3.810, W3 = 3.810	W1 = 150, W2 = 150, W3 = 150
TL222	0.019 λ , 20.93 Ω	W1 = 3.810, W2 = 3.810, W3 = 1.778	W1 = 150, W2 = 150, W3 = 70
TL225, TL227	0.023 λ , 20.93 Ω	W = 3.810, L = 2.078	W = 150, L = 82
TL226, TL228	0.066 λ , 20.93 Ω	W = 3.810, L = 6.020	W = 150, L = 237
TL229, TL232	0.028 λ , 20.93 Ω	W = 3.810, L = 2.540	W = 150, L = 100
TL231, TL233	0.097 λ , 20.93 Ω	W = 3.810, L = 8.915	W = 150, L = 351
TL234, TL235	0.019 λ , 20.93 Ω	W1 = 3.810, W2 = 3.810, W3 = 1.778	W1 = 150, W2 = 150, W3 = 70,
TL236	0.019 λ , 20.93 Ω	W = 3.810, L = 1.778	W = 150, L = 70
TL237	0.021 λ , 47.12 Ω	W1 = 1.270, W2 = 1.270, W3 = 2.032	W1 = 50, W2 = 50, W3 = 80
TL238 (taper)	0.009 λ , 7.95 Ω / 12.30 Ω	W1 = 11.557, W2 = 7.112, L = 0.787	W1 = 455, W2 = 280, L = 31

Reference Circuit (cont.)

Circuit Assembly Information

Test Fixture Part No. LTN/PTFB183404EF

Find Gerber files for this test fixture on the Wolfspeed Web site at www.wolfspeed.com/RF

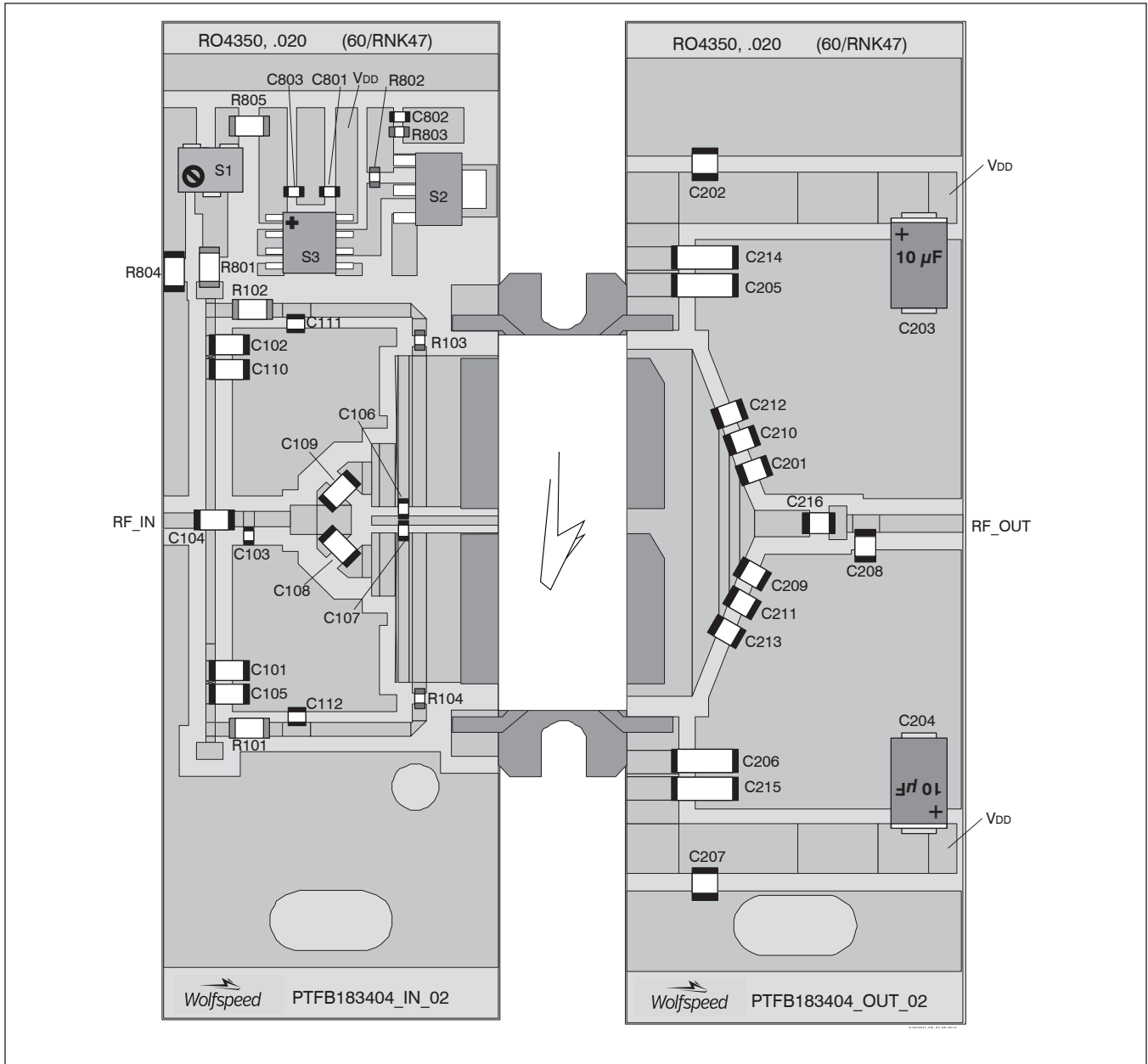

Reference circuit assembly diagram (not to scale)

Reference Circuit (cont.)

Component	Description	Suggested Manufacturer	P/N
Input			
C101, C110	Chip capacitor, 4.7 μ F	Digi-Key	PCS3475CT-ND
C102, C105	Chip capacitor, 0.1 μ F	Digi-Key	PCC104BCT-ND
C103	Chip capacitor, 0.7 pF	ATC	ATC100B0R7BW500XB
C104, C108, C109	Chip capacitor, 10 pF	ATC	ATC100B100JW500XB
C106, C107	Chip capacitor, 1.7 pF	ATC	ATC100A1R7BW150XB
C111, C112	Chip capacitor, 10 pF	ATC	ATC100A100JW500XB
C801, C802, C803	Chip capacitor, 1000 pF	Digi-Key	PCC1772CT-ND
R101, R102, R801, R804, R805	Resistor, 10 Ω	Digi-Key	P10ECT-ND
R103, R104	Resistor, 10 Ω	Digi-Key	P10GCT-ND
R802	Resistor, 1200 Ω	Digi-Key	P1.2KGCT-ND
R803	Resistor, 1300 Ω	Digi-Key	P1.3KGCT-ND
S1	Potentiometer, 2k Ω	Digi-Key	3224W-202ECT-ND
S2	Transistor	Digi-Key	BCP5616TA-ND
S3	Voltage Regulator	Digi-Key	LM7805
Output			
C201	Chip capacitor, 1.4 pF	ATC	ATC100B1R4BW500XB
C202, C207	Chip capacitor, 10 μ F	Digi-Key	587-1818-2-ND
C203, C204	Tantalum capacitor, 10 μ F	Digi-Key	TPSE106K050R0400
C205, C206	Chip capacitor, 2.2 μ F	Digi-Key	445-1447-2-ND
C208	Chip capacitor, 0.4 pF	ATC	ATC100B0R4BW500XB
C209	Chip capacitor, 1.8 pF	ATC	ATC100B1R8BW500XB
C210, C211, C212, C213	Chip capacitor, 1.3 pF	ATC	ATC100B1R3BW500XB
C214, C215	Chip capacitor, 1 μ F	Digi-Key	445-1411-2-ND
C216	Chip capacitor, 10 pF	ATC	ATC100B100JW500XB

Pinout Diagram

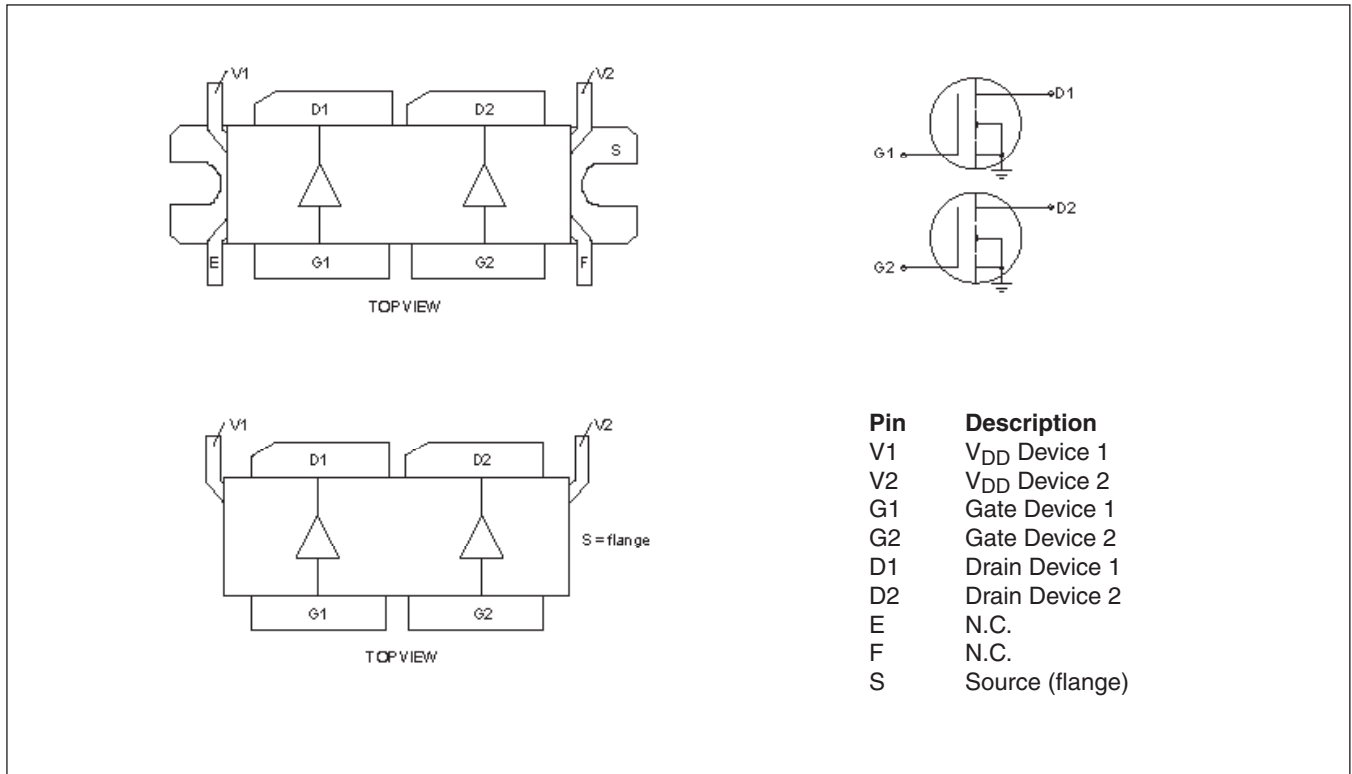

Package Outline Specifications

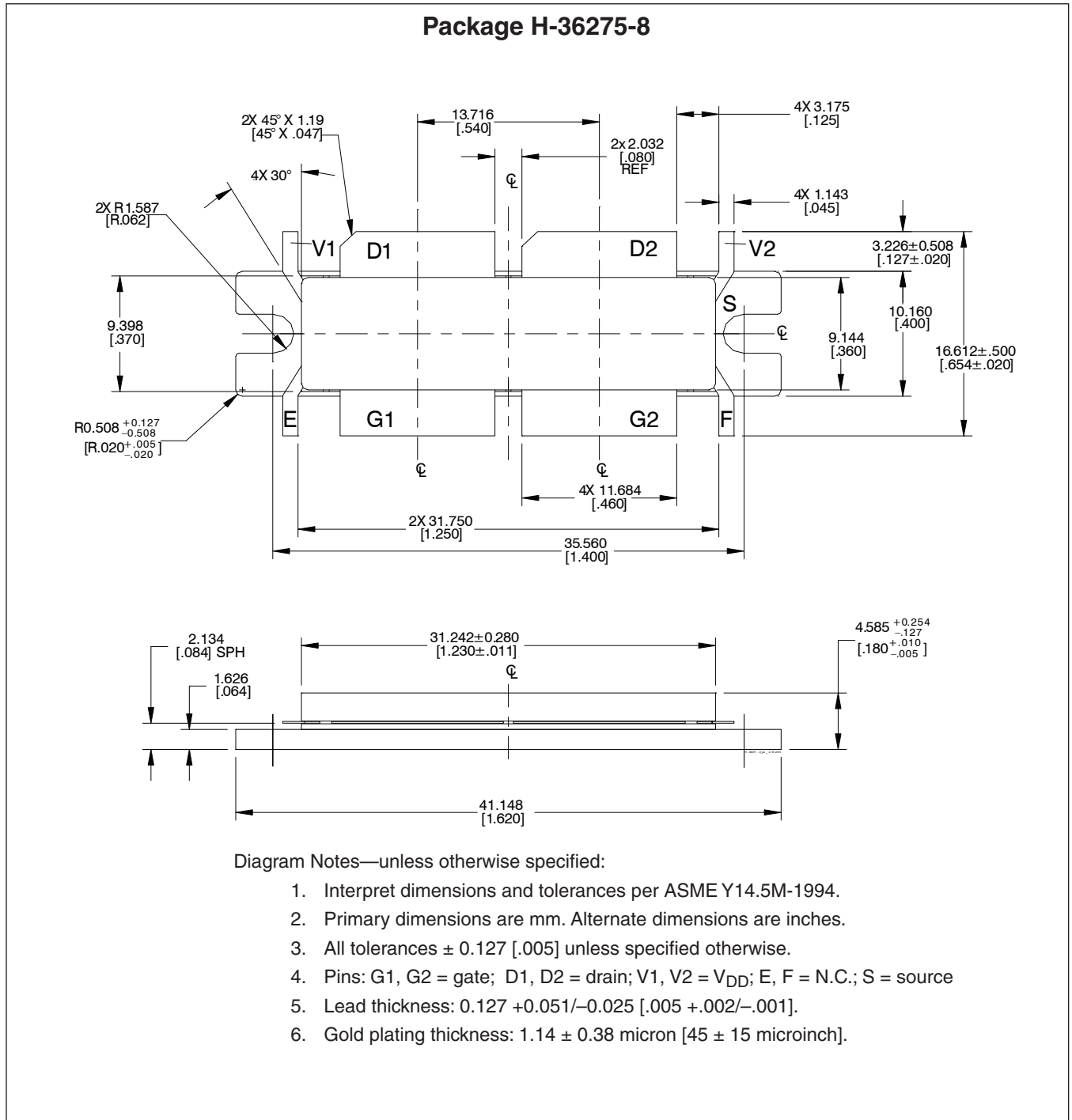

Package Outline Specifications (cont.)

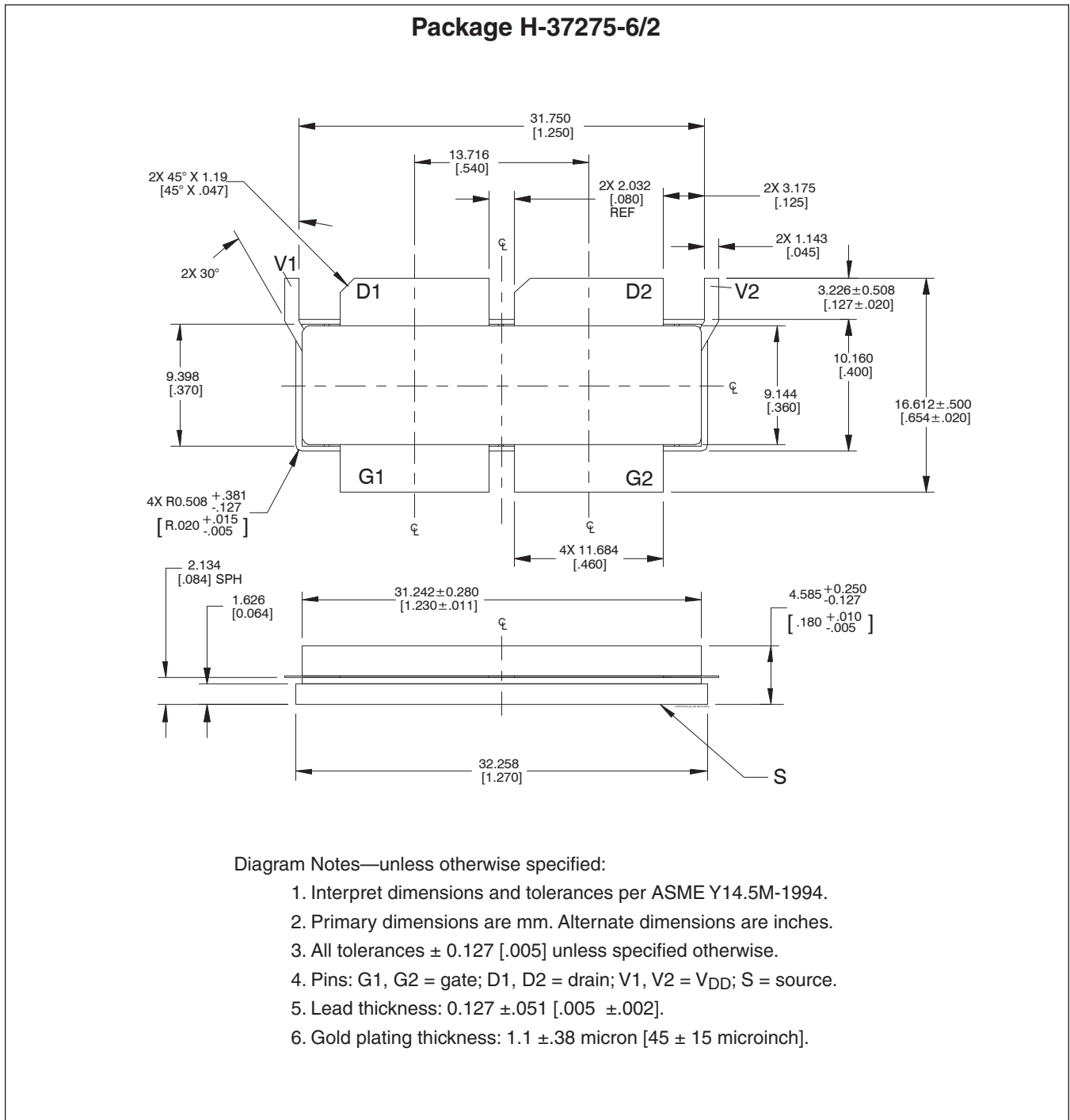

Revision History

Revision	Date	Data Sheet Type	Page	Subjects (major changes since last revision)
4.1	2016-06-10	Data Sheet	3	Updated ordering code
05	2018-06-25	Production	All	Converted to Wolfspeed Data Sheet

For more information, please contact:

4600 Silicon Drive
 Durham, North Carolina, USA 27703
www.wolfspeed.com/RF

Sales Contact
RFSales@wolfspeed.com

RF Product Marketing Contact
RFMarketing@wolfspeed.com
 919.407.7816

Notes

Disclaimer

Specifications are subject to change without notice. Cree, Inc. believes the information contained within this data sheet to be accurate and reliable. However, no responsibility is assumed by Cree for any infringement of patents or other rights of third parties which may result from its use. No license is granted by implication or otherwise under any patent or patent rights of Cree. Cree makes no warranty, representation or guarantee regarding the suitability of its products for any particular purpose. "Typical" parameters are the average values expected by Cree in large quantities and are provided for information purposes only. These values can and do vary in different applications and actual performance can vary over time. All operating parameters should be validated by customer's technical experts for each application. Cree products are not designed, intended or authorized for use as components in applications intended for surgical implant into the body or to support or sustain life, in applications in which the failure of the Cree product could result in personal injury or death or in applications for planning, construction, maintenance or direct operation of a nuclear facility.