

PXFE181507FC

Thermally-Enhanced High Power RF LDMOS FET 175 W, 28 V, 1805 – 1880 MHz

Description

The PXFE181507FC is a 175-watt LDMOS FET intended for use in multi-standard cellular power amplifier applications in the 1805 to 1880 MHz frequency band. Features include input and output matching, high gain and thermally-enhanced package with earless flange. Manufactured with Wolfspeed's advanced LDMOS process, this device provides excellent thermal performance and superior reliability

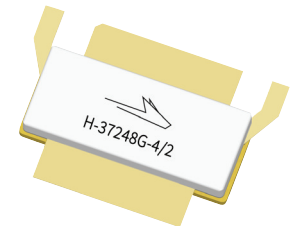

PXFE181507FC
Package H-37248G-4/2

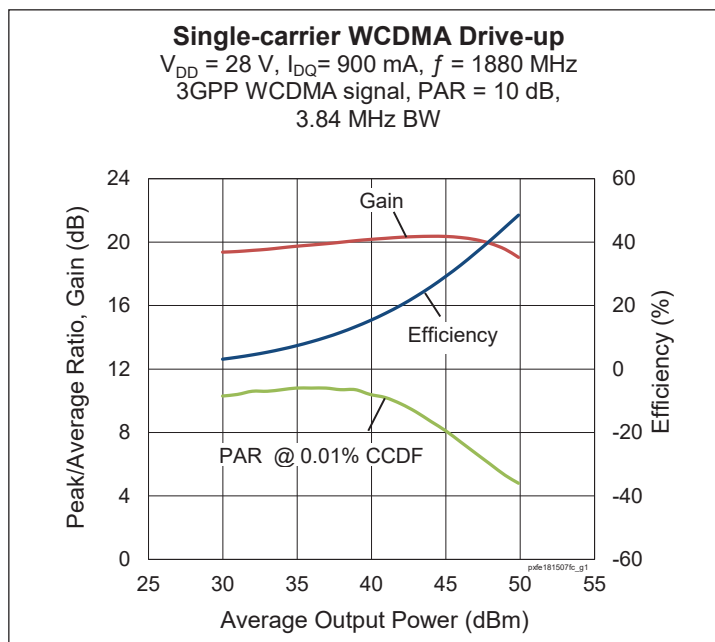

Features

- Broadband internal input and output matching
- Typical Pulsed CW performance, 1842 MHz, 28 V, single side, 16 μs , 10% duty cycle, class AB test
 - Output power at $P_{1dB} = 175\text{ W}$
 - Output power at $P_{3dB} = 222\text{ W}$
 - Efficiency at $P_{3dB} = 60\%$
 - Gain = 21.3 dB
- Capable of handling 10:1 VSWR @ 28 V, 180 W (CW) output power
- Human Body Model Class 2 (per ANSI/ESDA/JEDEC JS-001)
- Integrated ESD protection
- Low thermal resistance
- Pb-free and RoHS compliant

RF Characteristics

Single-carrier WCDMA Specifications (tested in Wolfspeed production test fixture)

$V_{DD} = 28\text{ V}$, $I_{DQ} = 900\text{ mA}$, $P_{OUT} = 50\text{ W avg}$, $f = 1880\text{ MHz}$, 3GPP signal, channel bandwidth = 3.84 MHz, peak/average = 10 dB @ 0.01% CCDF

Characteristic	Symbol	Min	Typ	Max	Unit
Gain	G_{ps}	19	20	—	dB
Drain Efficiency	η_D	32	36	—	%
Adjacent Channel Power Ratio	ACPR	—	-31	-27	dBc
Output PAR at 0.01% probability on CCDF	OPAR	5.7	6.2	—	dB

All published data at $T_{CASE} = 25^\circ\text{C}$ unless otherwise indicated

ESD: Electrostatic discharge sensitive device—observe handling precautions!

DC Characteristics

Characteristic	Conditions	Symbol	Min	Typ	Max	Unit
Drain-Source Breakdown Voltage	$V_{GS} = 0\text{ V}, I_{DS} = 10\text{ mA}$	$V_{(BR)DSS}$	65	—	—	V
Drain Leakage Current	$V_{DS} = 28\text{ V}, V_{GS} = 0\text{ V}$	I_{DSS}	—	—	1	μA
	$V_{DS} = 63\text{ V}, V_{GS} = 0\text{ V}$	I_{DSS}	—	—	10	μA
Gate Leakage Current	$V_{GS} = 10\text{ V}, V_{DS} = 0\text{ V}$	I_{GSS}	—	—	1	μA
On-State Resistance	$V_{GS} = 10\text{ V}, V_{DS} = 0.1\text{ V}$	$R_{DS(on)}$	—	0.08	—	Ω
Operating Gate Voltage	$V_{DS} = 28\text{ V}, I_{DQ} = 900\text{ mA}$	V_{GS}	2.6	3.0	3.4	V

Maximum Ratings

Parameter	Symbol	Value	Unit
Drain-Source Voltage	V_{DSS}	65	V
Gate-Source Voltage	V_{GS}	-6 to +10	V
Operating Voltage	V_{DD}	0 to +32	V
Junction Temperature	T_J	225	$^{\circ}\text{C}$
Storage Temperature Range	T_{STG}	-65 to +150	$^{\circ}\text{C}$

Thermal Characteristics

Characteristic	Symbol	Value	Unit
Thermal Resistance ($T_{CASE} = 70^{\circ}\text{C}, 50\text{ W CW}$)	$R_{\theta JC}$	0.55	$^{\circ}\text{C/W}$

Ordering Information

Type and Version	Order Code	Package	Shipping
PXFE181507FC V1 R0	PXFE181507FC-V1-R0	H-37248G-4/2	Tape & Reel, 50 pcs
PXFE181507FC V1 R2	PXFE181507FC-V1-R2	H-37248G-4/2	Tape & Reel, 250 pcs

Typical Performance (data taken in test fixture)

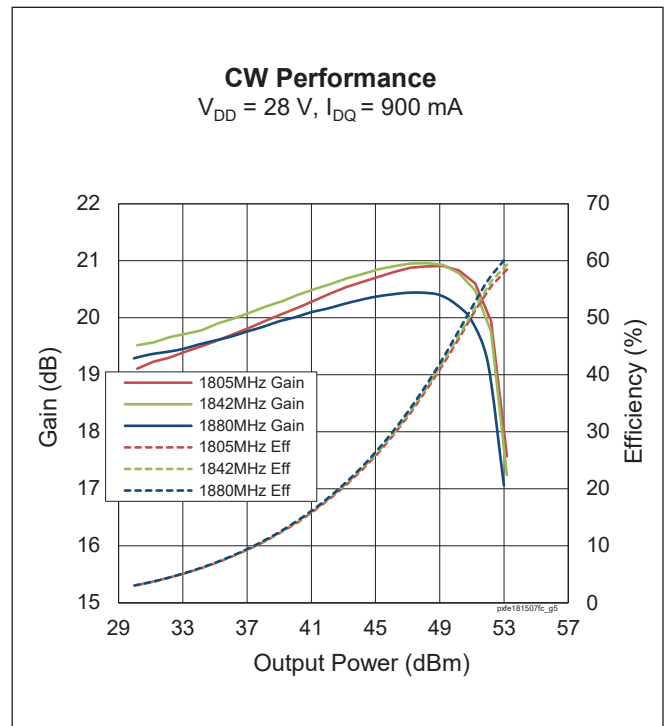
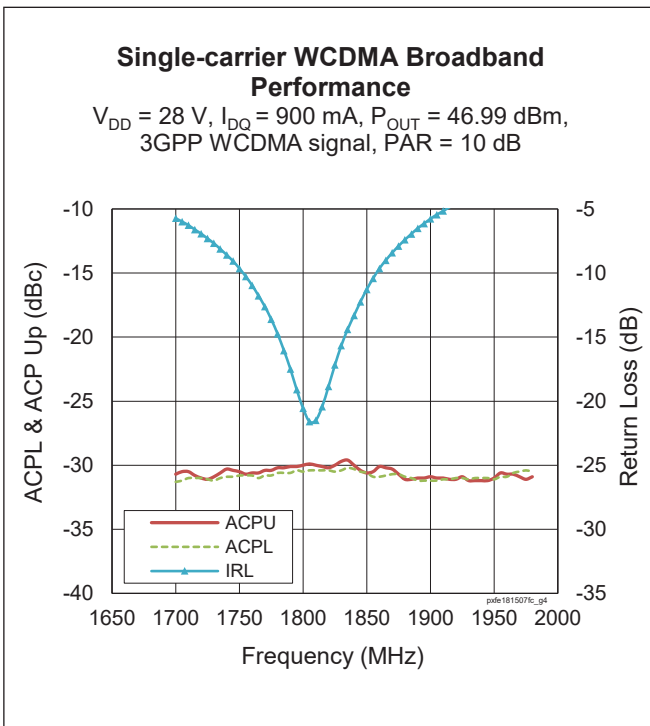
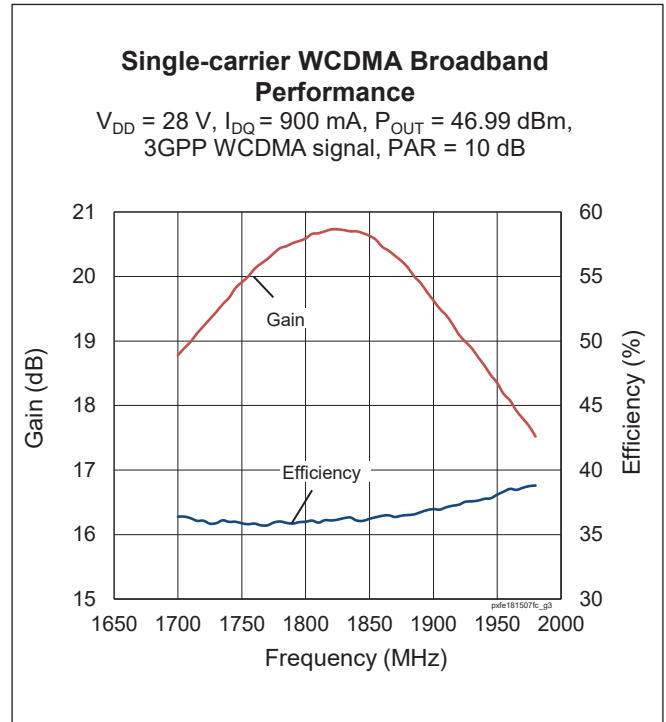
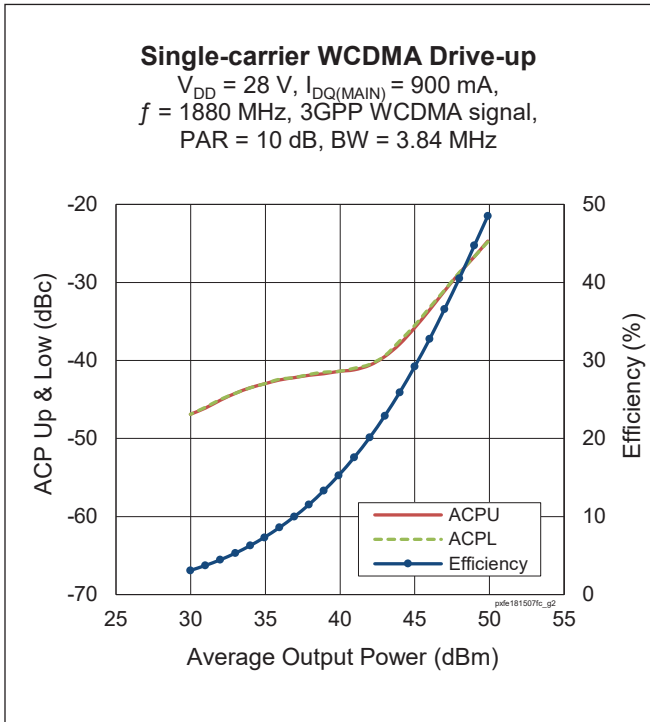

Typical Performance (cont.)

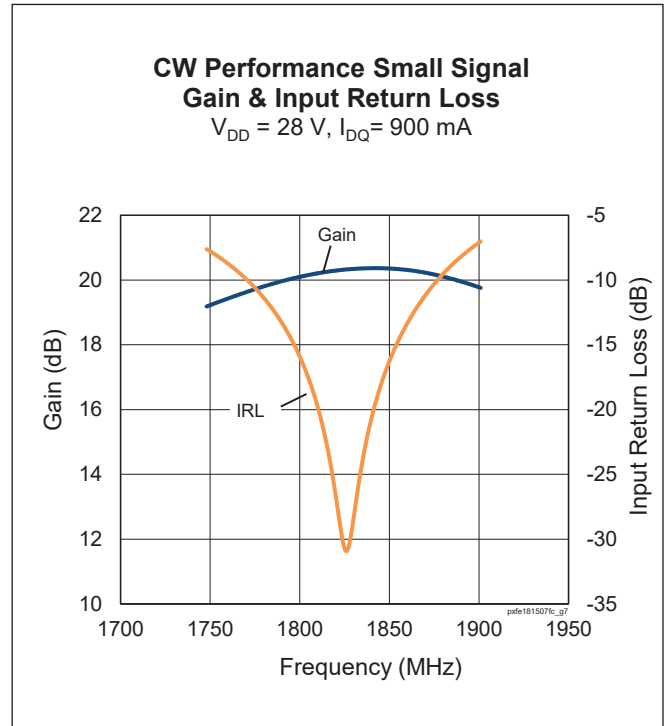
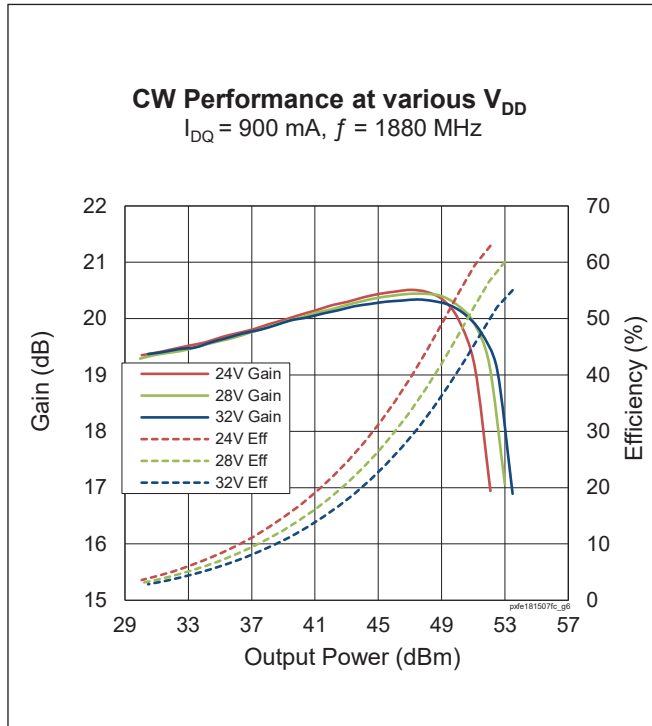

Load Pull Performance

Each Side Load Pull Performance – Pulsed CW signal: 16 μs , 10% duty cycle, 28 V, $I_{DQ} = 900 \text{ mA}$

		P_{1dB}									
		Max Output Power					Max Drain Efficiency				
Freq [MHz]	Zs [W]	ZL [W]	Gain [dB]	P_{1dB} [dBm]	P_{1dB} [W]	η_D [%]	ZL [W]	Gain [dB]	P_{1dB} [dBm]	P_{1dB} [W]	η_D [%]
1810	7.5-j5.6	1.61-j3.21	19.79	52.87	193.6	59.6	4.1-j0.6	22.6	49.9	98	70.4
1880	12.6-j7	1.38-j2.91	20.15	52.78	189.67	56.94	3.29-j1.56	22.63	50.6	114.8	69

		P_{3dB}									
		Max Output Power					Max Drain Efficiency				
Freq [MHz]	Zs [W]	ZL [W]	Gain [dB]	P_{3dB} [dBm]	P_{3dB} [W]	η_D [%]	ZL [W]	Gain [dB]	P_{3dB} [dBm]	P_{3dB} [W]	η_D [%]
1810	7.5-j5.6	1.61-j3.21	17.79	53.64	231.2	62.47	3.12-j1.98	19.72	52.03	159.6	70.93
1880	12.6-j7	1.58-j3.47	17.83	53.57	227.5	58.69	3.13-j1.84	20.44	51.67	146.9	70.74

Reference Circuit, 1805 – 1880 MHz

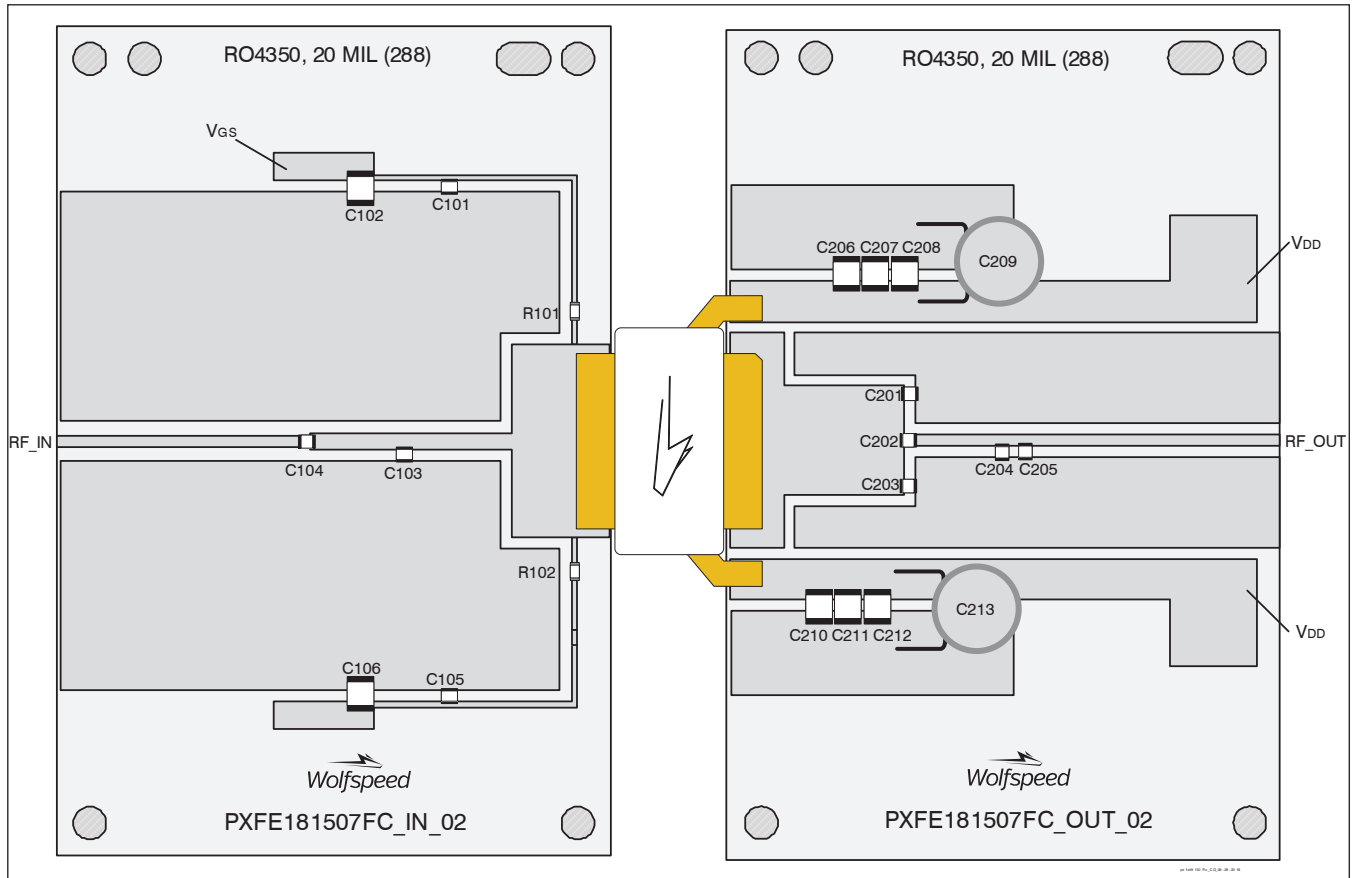

Reference circuit assembly diagram (not to scale)

Reference Circuit Assembly

DUT	PXFE181507FC V1
Test Fixture Part No.	LTN/PXFE181507FC V1
PCB	Rogers 4350, 0.508 mm [0.020"] thick, 2 oz. copper, $\epsilon_r = 3.66$, $f = 1805 - 1880$ MHz
Find Gerber files for this test fixture on the Wolfspeed Web site at www.wolfspeed.com/RF	

Components Information

Component	Description	Manufacturer	P/N
Input			
C101, C104, C105	Capacitor, 12 pF	ATC	ATC600F120JT250XT
C102, C106	Capacitor, 10 μ F, 50 V	Taiyo Yuden	UMK325C7106MM-T
C103	Capacitor, 1 pF	ATC	ATC600F1R0CT250XT
R101, R102	Resistor, 10 ohms	Panasonic Electronic Components	ERJ-3GEYJ100V
Output			
C201, C203, C204	Capacitor, 0.2 pF	ATC	ATC600F0R2BT250XT
C202	Capacitor, 12 pF	ATC	ATC600F120JT250XT
C205	Capacitor, 0.4 pF	ATC	ATC600F0R4BT250XT
C206, C207, C208, C210, C211, C212	Capacitor, 10 μ F, 50 V	Taiyo Yuden	UMK325C7106MM-T
C209, C213	Capacitor, 220 μ F, 100 V	Panasonic Electronic Components	ECA-2AHG221



Pinout Diagram (top view)

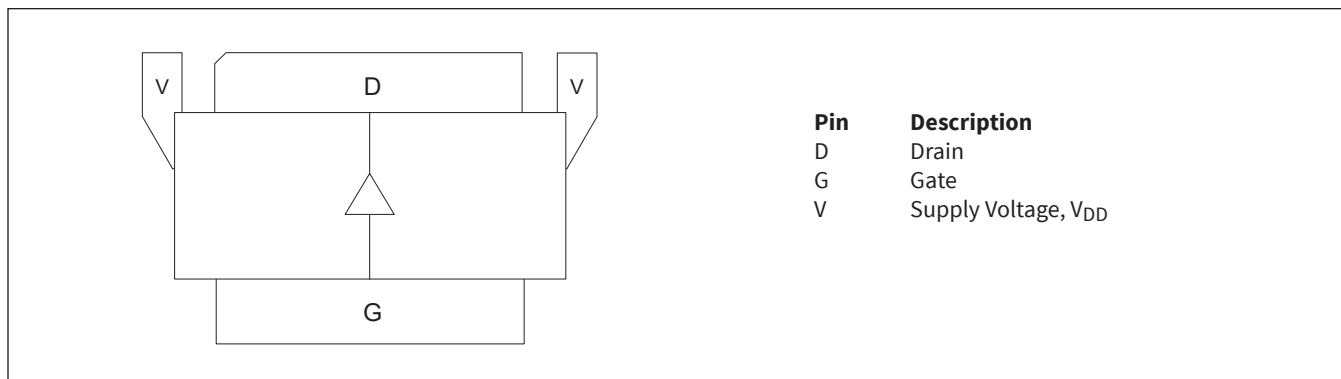

Lead connections for PXFE181507FC

See next page for Package Outline Specifications

Package Outline Specifications

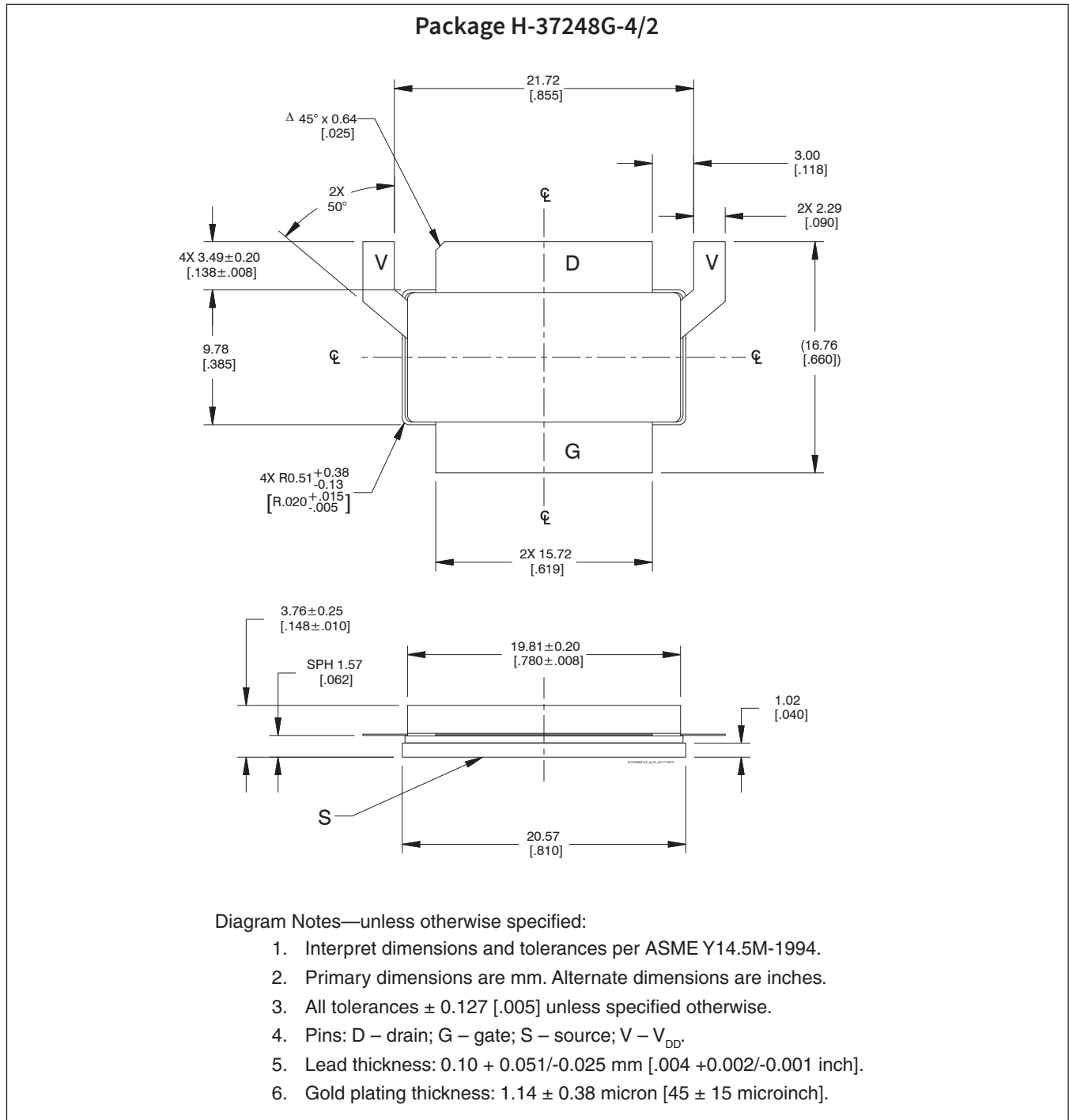

Revision History

01	2018-02-07	Advance	All	Data Sheet reflects advance specification for product development
01.1	2018-03-26	Advance	1, 4	Added typical pulsed CW performance, updated TBD numbers with latest specs, added pinout
01.2	2018-07-29	Production	All	Converted to Wolfspeed data sheet
02	2018-08-30	Production	All	Data Sheet reflects released product specification

For more information, please contact:

4600 Silicon Drive
 Durham, North Carolina, USA 27703
www.wolfspeed.com/RF

Sales Contact
RFSales@wolfspeed.com

RF Product Marketing Contact
RFMarketing@wolfspeed.com
 919.407.7816

Notes

Disclaimer

Specifications are subject to change without notice. Cree, Inc. believes the information contained within this data sheet to be accurate and reliable. However, no responsibility is assumed by Cree for any infringement of patents or other rights of third parties which may result from its use. No license is granted by implication or otherwise under any patent or patent rights of Cree. Cree makes no warranty, representation or guarantee regarding the suitability of its products for any particular purpose. "Typical" parameters are the average values expected by Cree in large quantities and are provided for information purposes only. These values can and do vary in different applications and actual performance can vary over time. All operating parameters should be validated by customer's technical experts for each application. Cree products are not designed, intended or authorized for use as components in applications intended for surgical implant into the body or to support or sustain life, in applications in which the failure of the Cree product could result in personal injury or death or in applications for planning, construction, maintenance or direct operation of a nuclear facility.