

CGH27030

30 W, 28V, GaN HEMT for Linear Communications ranging from VHF to 3 GHz

Cree's CGH27030 is a gallium nitride (GaN) high electron mobility transistor (HEMT) designed specifically for high efficiency, high gain and wide bandwidth capabilities, which makes the CGH27030 ideal for VHF, Comms, 3G, 4G, LTE, 2.3-2.9GHz WiMAX and BWA amplifier applications. The unmatched transistor is available in both screw-down, flange and solder-down, pill packages.

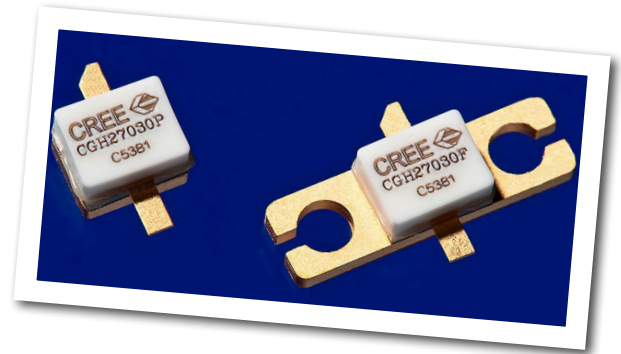

Package Type: 440196 and 440166
PN: CGH27030P and CGH27030F

Typical Performance Over 2.3-2.7GHz ($T_c = 25^\circ\text{C}$) of Demonstration Amplifier

Parameter	2.3 GHz	2.4 GHz	2.5 GHz	2.6 GHz	2.7 GHz	Units
Small Signal Gain	15.6	15.5	15.3	15.1	15.2	dB
EVM at $P_{AVE} = 36$ dBm	1.73	1.85	1.85	1.77	1.43	%
Drain Efficiency at 36 dBm	28.1	28.7	28.9	27.9	27.5	%
Input Return Loss	6.6	6.2	6.0	6.1	7.0	dB

Note:

Measured in the CGH27030F-AMP amplifier circuit, under 802.16 OFDM, 3.5 MHz Channel BW, 1/4 Cyclic Prefix, 64 QAM Modulated Burst, 5 ms Burst, Symbol Length of 59, Coding Type RS-CC, Coding Rate Type 2/3, PAR = 9.8 dB @ 0.01 % Probability on CCDF.

Features



- VHF - 3.0 GHz Operation
- 30 W Peak Power Capability
- 15 dB Small Signal Gain
- 4.0 W P_{AVE} at < 2.0 % EVM
- 28 % Drain Efficiency at 4 W Average Power
- WiMAX Fixed Access 802.16-2004 OFDM
- WiMAX Mobile Access 802.16e OFDMA

Large Signal Models Available for ADS and MWO

Absolute Maximum Ratings (not simultaneous) at 25°C Case Temperature

Parameter	Symbol	Rating	Units	Conditions
Drain-Source Voltage	V_{DSS}	84	Volts	25°C
Gate-to-Source Voltage	V_{GS}	-10, +2	Volts	25°C
Power Dissipation	P_{DISS}	14	Watts	
Storage Temperature	T_{STG}	-65, +150	°C	
Operating Junction Temperature	T_J	225	°C	
Maximum Forward Gate Current	I_{GMAX}	4.0	mA	25°C
Maximum Drain Current ¹	I_{DMAX}	3.0	A	25°C
Soldering Temperature ²	T_S	245	°C	
Screw Torque	τ	60	in-oz	
Thermal Resistance, Junction to Case ³	$R_{\theta JC}$	4.8	°C/W	85°C
Case Operating Temperature ³	T_C	-40, +150	°C	

Note:

¹ Current limit for long term, reliable operation.

² Refer to the Application Note on soldering at www.cree.com/RF/Document-Library

³ Measured for the CGH27030F at $P_{DISS} = 14\text{ W}$

Electrical Characteristics ($T_c = 25^\circ\text{C}$)

Characteristics	Symbol	Min.	Typ.	Max.	Units	Conditions
DC Characteristics¹						
Gate Threshold Voltage	$V_{GS(th)}$	-3.8	-3.0	-2.3	V_{DC}	$V_{DS} = 10\text{ V}, I_D = 7.2\text{ mA}$
Gate Quiescent Voltage	$V_{GS(Q)}$	-	-2.7	-	V_{DC}	$V_{DS} = 28\text{ V}, I_D = 150\text{ mA}$
Saturated Drain Current	I_{DS}	5.8	7.0	-	A	$V_{DS} = 6.0\text{ V}, V_{GS} = 2\text{ V}$
Drain-Source Breakdown Voltage	V_{BR}	120	-	-	V_{DC}	$V_{GS} = -8\text{ V}, I_D = 7.2\text{ mA}$
RF Characteristics^{2,3} ($T_c = 25^\circ\text{C}$, $F_0 = 2.5\text{ GHz}$ unless otherwise noted)						
Small Signal Gain	G_{SS}	12.5	14.5	-	dB	$V_{DD} = 28\text{ V}, I_{DQ} = 150\text{ mA}$
Drain Efficiency ⁴	η	23.0	28.0	-	%	$V_{DD} = 28\text{ V}, I_{DQ} = 150\text{ mA}, P_{AVE} = 4\text{ W}$
Error Vector Magnitude	EVM	-	2.0	-		$V_{DD} = 28\text{ V}, I_{DQ} = 150\text{ mA}, P_{AVE} = 4\text{ W}$
Output Mismatch Stress	VSWR	-	-	10 : 1	Y	No damage at all phase angles, $V_{DD} = 28\text{ V}, I_{DQ} = 150\text{ mA}$ $P_{AVE} = 4.0\text{ W OFDM } P_{AVE}$
Dynamic Characteristics⁵						
Input Capacitance	C_{GS}	-	9.0	-	pF	$V_{DS} = 28\text{ V}, V_{gs} = -8\text{ V}, f = 1\text{ MHz}$
Output Capacitance	C_{DS}	-	2.6	-	pF	$V_{DS} = 28\text{ V}, V_{gs} = -8\text{ V}, f = 1\text{ MHz}$
Feedback Capacitance	C_{GD}	-	0.4	-	pF	$V_{DS} = 28\text{ V}, V_{gs} = -8\text{ V}, f = 1\text{ MHz}$

Notes:

¹ Measured on wafer prior to packaging.

² Measured in the CGH27030F-AMP test fixture.

³ Under 802.16 OFDM, 3.5 MHz Channel BW, 1/4 Cyclic Prefix, 64 QAM Modulated Burst, 5 ms Burst, Symbol Length of 59, Coding Type RS-CC, Coding Rate Type 2/3, PAR = 9.8 dB @ 0.01 % Probability on CCDF.

⁴ Drain Efficiency = P_{out} / P_{dc} .

⁵ Capacitance values include package parasitics.

Typical WiMAX Performance

Small Signal S-Parameters vs Frequency measured in CGH27030F-AMP
 $V_{DD} = 28\text{ V}$, $I_{DQ} = 150\text{ mA}$

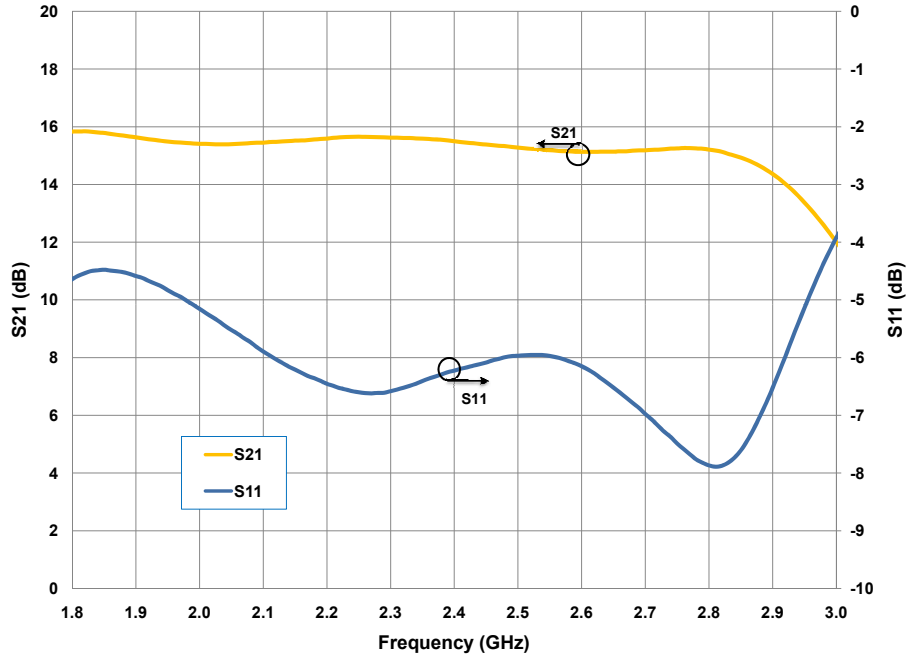

Typical EVM and Efficiency versus Frequency measured in CGH27030F-AMP
 $V_{DD} = 28\text{ V}$, $I_{DQ} = 150\text{ mA}$, 802.16-2004 OFDM, PAR=9.8 dB, $P_{AVE} = 5\text{ W}$

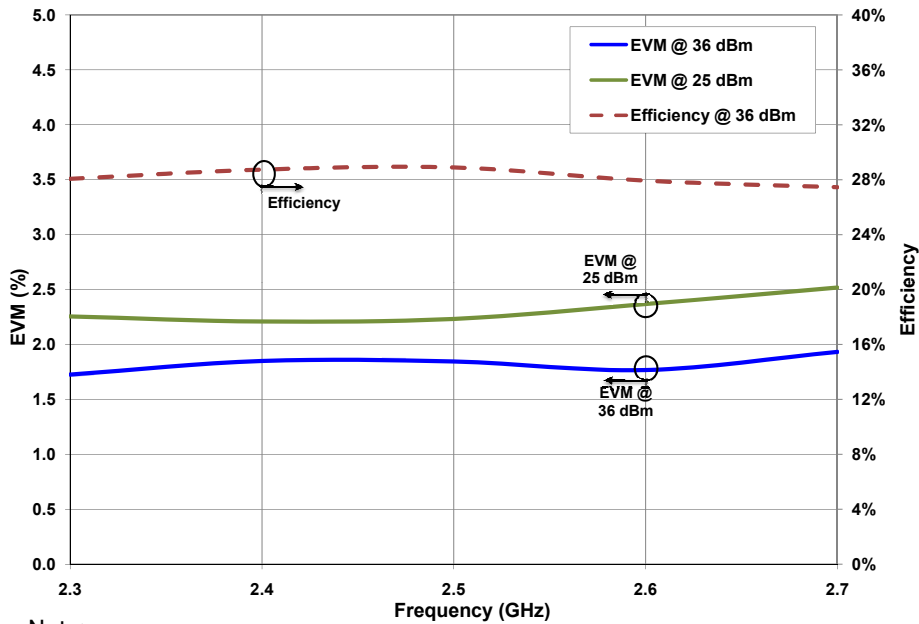

Note:

Under 802.16 OFDM, 3.5 MHz Channel BW, 1/4 Cyclic Prefix, 64 QAM Modulated Burst, Symbol Length of 59, Coding Type RS-CC, Coding Rate Type 2/3, PAR = 9.8 dB @ 0.01 % Probability on CCDF.

Typical WiMAX Performance

Drain Efficiency and EVM vs Output Power measured in CGH27030F-AMP
 $V_{DD} = 28\text{ V}$, $I_{DQ} = 150\text{ mA}$, 802.16-2004 OFDM, PAR = 9.8 dB

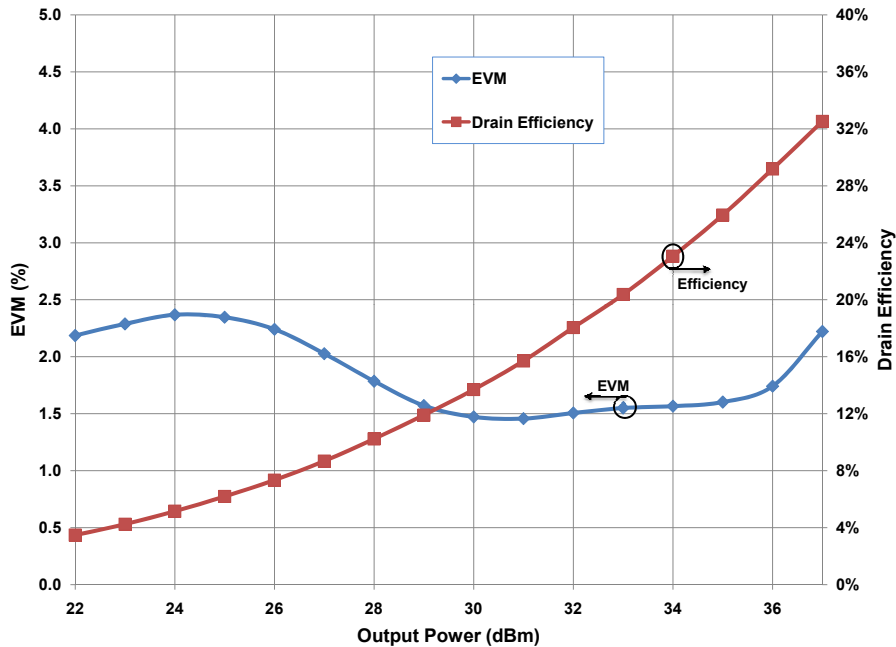

Typical Gain and Efficiency versus Output Power measured in CGH27030F-AMP
 $V_{DD} = 28\text{ V}$, $I_{DQ} = 150\text{ mA}$, 802.16-2004 OFDM, PAR=9.8 dB

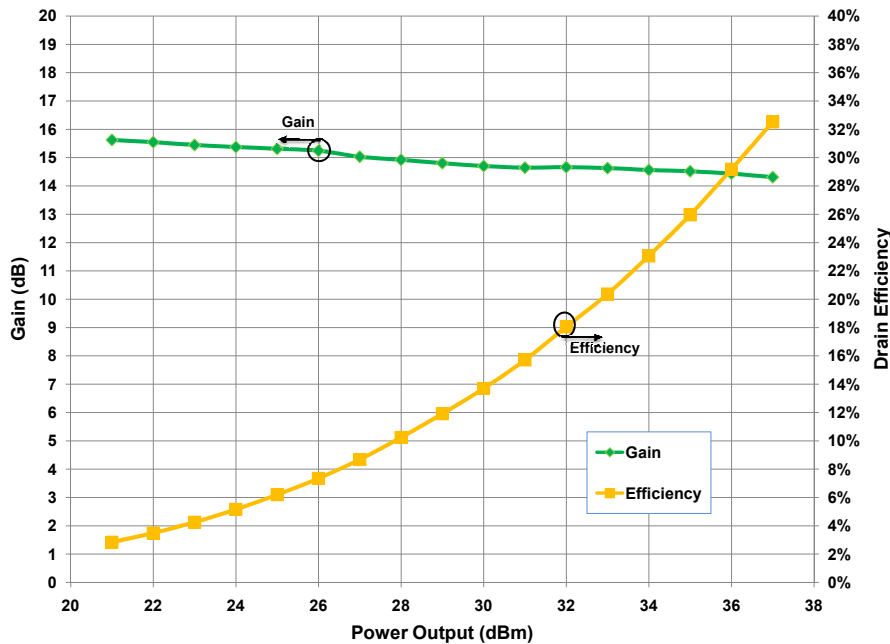

Note:

Under 802.16 OFDM, 3.5 MHz Channel BW, 1/4 Cyclic Prefix, 64 QAM Modulated Burst, Symbol Length of 59, Coding Type RS-CC, Coding Rate Type 2/3, PAR = 9.8 dB @ 0.01 % Probability on CCDF.

Typical Performance Data

Simulated Maximum Available Gain and K Factor of the CGH27030F
 $V_{DD} = 28\text{ V}, I_{DQ} = 150\text{ mA}$

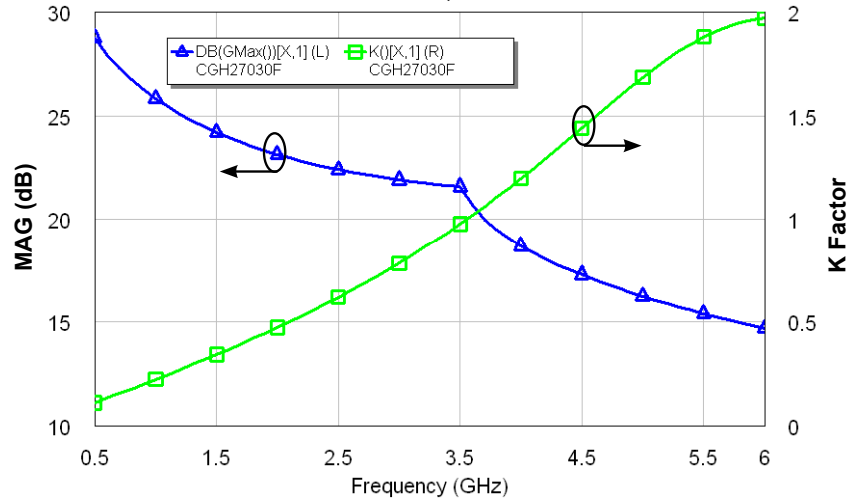

Typical Noise Performance

Simulated Minimum Noise Figure and Noise Resistance vs Frequency of the CGH27030
 $V_{DD} = 28\text{ V}, I_{DQ} = 150\text{ mA}$

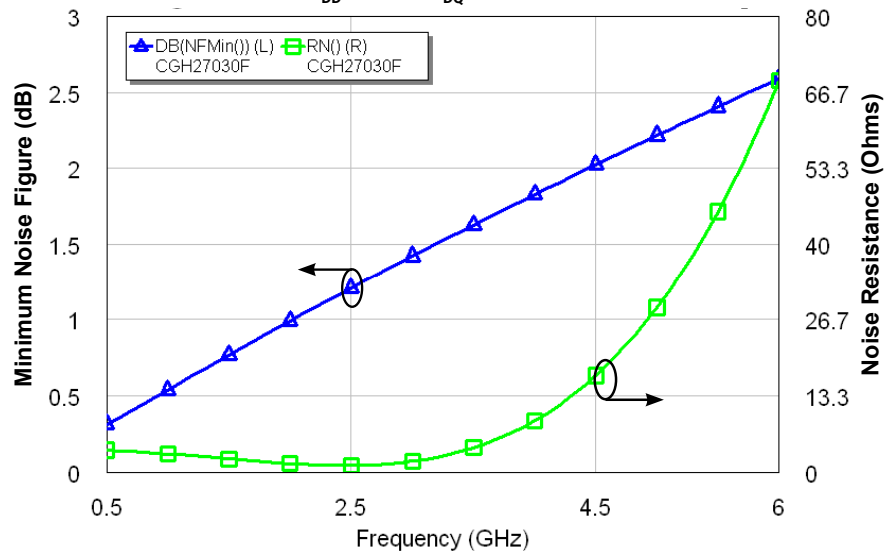

Electrostatic Discharge (ESD) Classifications

Parameter	Symbol	Class	Test Methodology
Human Body Model	HBM	1A (> 250 V)	JEDEC JESD22 A114-D
Charge Device Model	CDM	II (200 < 500 V)	JEDEC JESD22 C101-C

Source and Load Impedances

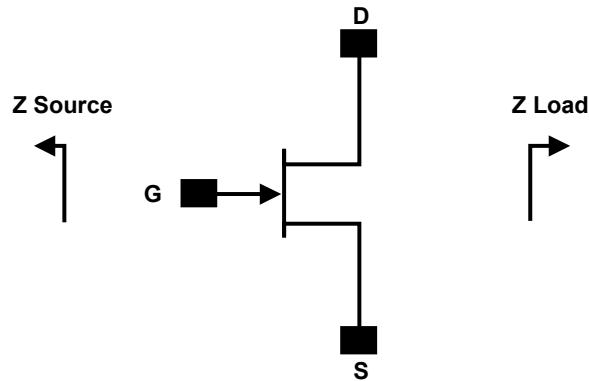

Frequency (MHz)	Z Source	Z Load
500	7.75 + j15.5	20 + j5.2
1000	3.11 + j5.72	17 + j6.66
1500	2.86 + j1.63	16.8 + j3.2
2500	1.2 - j3.26	9.41 + j3.2
3500	1.31 - j7.3	5.85 - j0.51

Note 1. $V_{DD} = 28V$, $I_{DQ} = 250mA$ in the 440166 package.

Note 2. Optimized for power gain, P_{SAT} and PAE.

Note 3. When using this device at low frequency, series resistors should be used to maintain amplifier stability.

CGH27030 Power Dissipation De-rating Curve

CGH27030 Average Power Dissipation De-rating Curve

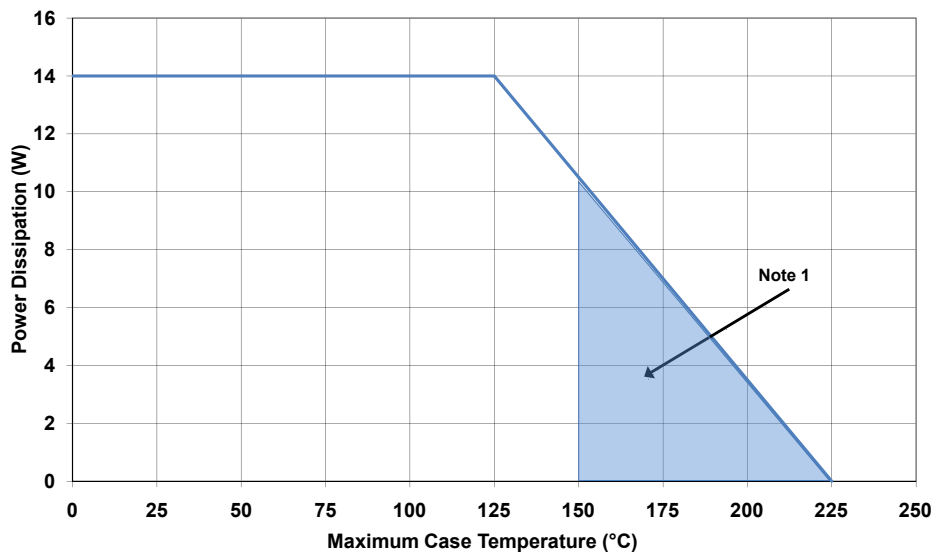

Note 1. Area exceeds Maximum Case Operating Temperature (See Page 2).

CGH27030F-AMP Demonstration Amplifier Circuit Bill of Materials

Designator	Description	Qty
R1	RES,1/16W,0603,1%,100 OHMS	1
R2	RES,1/16W,0603,1%,47 OHMS	1
C5	CAP, 470PF, 5%,100V, 0603	1
C15	CAP, 33 UF, 20%, G CASE	1
C14	CAP, 1.0UF, 100V, 10%, X7R, 1210	1
C7	CAP 10UF 16V TANTALUM	1
C12	CAP, 100.0pF, +/-5%, 0603	1
C1	CAP, 1.6pF, +/-0.1pF, 0603	1
C2	CAP, 1.8pF, +/-0.1pF, 0603	1
C3,C10	CAP, 10.0pF,+/-5%, 0603	2
C4,C11	CAP, 39pF, +/-5%, 0603	2
C8,C9	CAP, 3.0pF, +/-0.1pF, 0603	2
C6,C13	CAP,33000PF, 0805,100V, X7R	2
J3,J4	CONN SMA STR PANEL JACK RECP	1
J2	HEADER RT>PLZ.1CEN LK 2 POS	1
J1	HEADER RT>PLZ. .1CEN LK 5POS	1
-	PCB, RO4350B, Er = 3.48, h = 20 mil	1
-	CGH27030F	1

CGH27030F-AMP Demonstration Amplifier Circuit

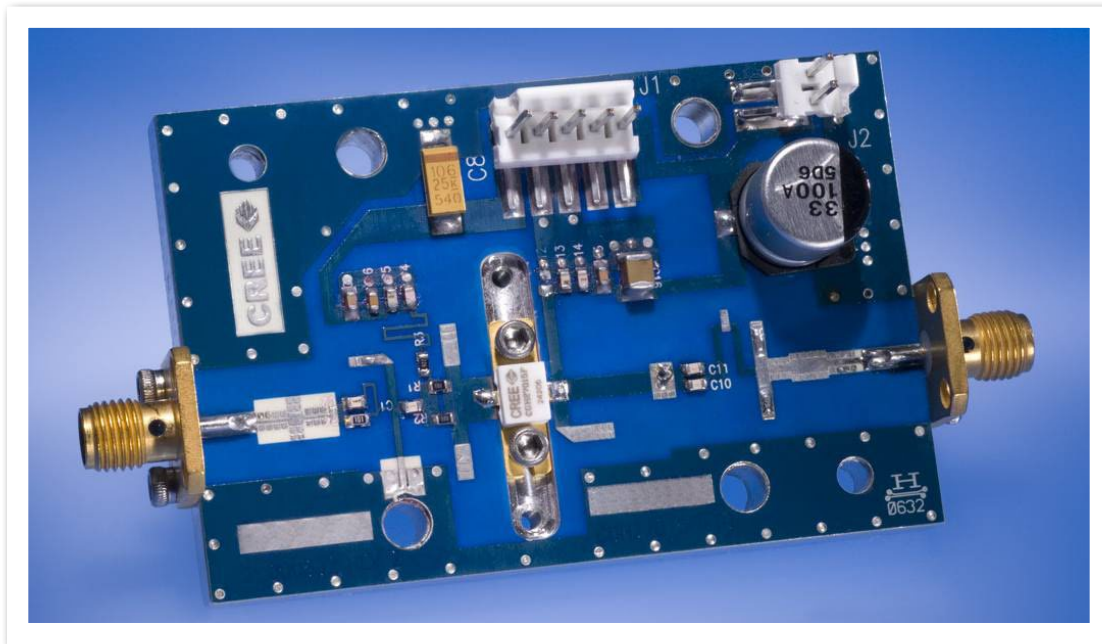

CGH27030F-AMP Demonstration Amplifier Circuit Schematic

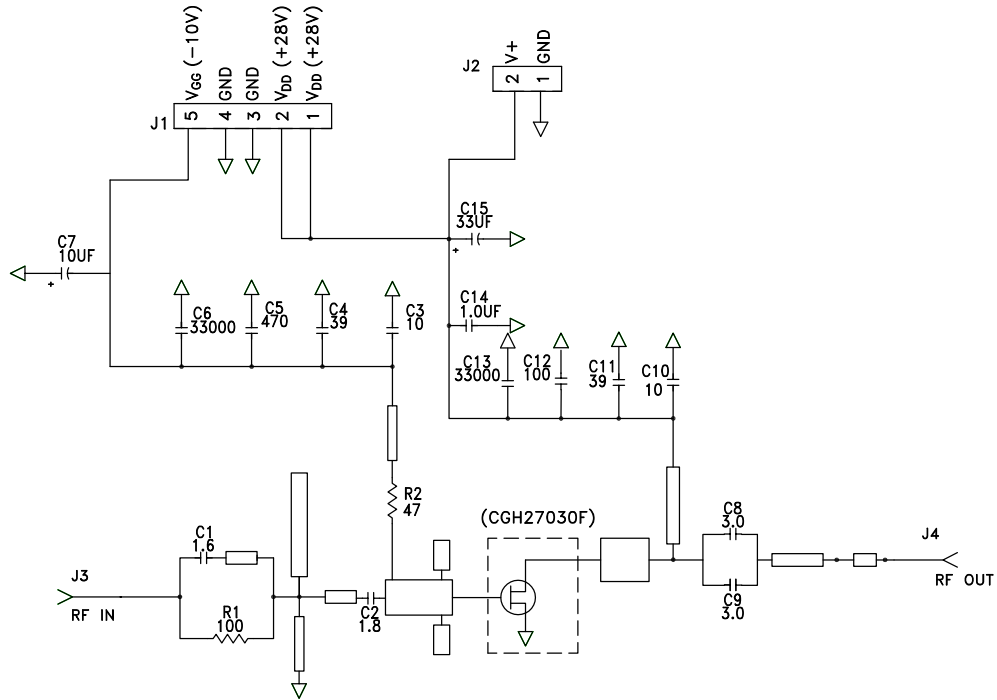

CGH27030F-AMP Demonstration Amplifier Circuit Outline

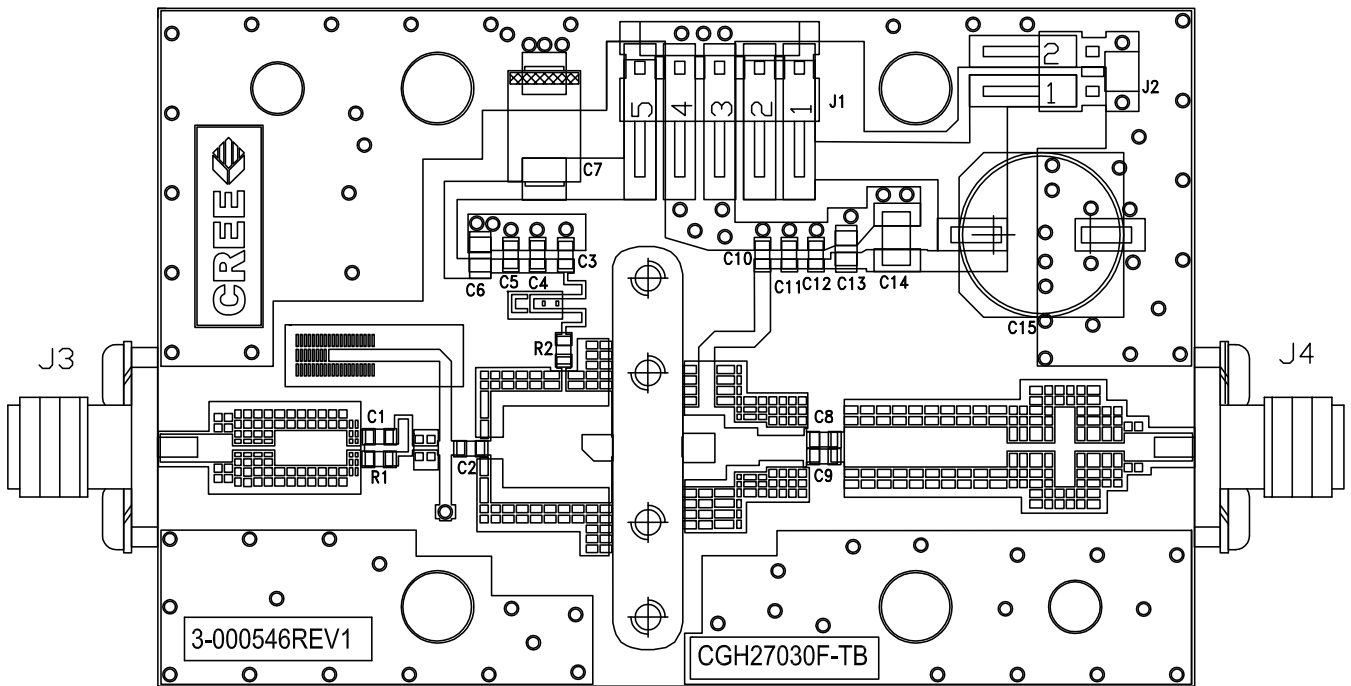

Typical Package S-Parameters for CGH27030
 (Small Signal, $V_{DS} = 28\text{ V}$, $I_{DQ} = 150\text{ mA}$, angle in degrees)

Frequency	Mag S11	Ang S11	Mag S21	Ang S21	Mag S12	Ang S12	Mag S22	Ang S22
500 MHz	0.910	-127.91	18.04	106.46	0.024	20.12	0.314	-103.83
600 MHz	0.904	-137.21	15.52	100.35	0.025	14.75	0.306	-111.67
700 MHz	0.900	-144.50	13.58	95.23	0.025	10.38	0.302	-117.66
800 MHz	0.897	-150.40	12.04	90.78	0.025	6.69	0.302	-122.33
900 MHz	0.895	-155.33	10.80	86.81	0.026	3.48	0.303	-126.06
1.0 GHz	0.894	-159.54	9.78	83.20	0.026	0.63	0.306	-129.12
1.1 GHz	0.893	-163.21	8.93	79.85	0.026	-1.95	0.310	-131.69
1.2 GHz	0.892	-166.46	8.22	76.69	0.025	-4.31	0.315	-133.89
1.3 GHz	0.891	-169.40	7.60	73.70	0.025	-6.51	0.321	-135.84
1.4 GHz	0.891	-172.09	7.07	70.84	0.025	-8.56	0.327	-137.59
1.5 GHz	0.891	-174.57	6.61	68.08	0.025	-10.50	0.334	-139.20
1.6 GHz	0.891	-176.88	6.20	65.41	0.025	-12.34	0.341	-140.70
1.7 GHz	0.891	-179.07	5.84	62.81	0.025	-14.09	0.348	-142.13
1.8 GHz	0.891	178.86	5.52	60.28	0.025	-15.76	0.355	-143.51
1.9 GHz	0.891	176.88	5.23	57.79	0.024	-17.36	0.362	-144.85
2.0 GHz	0.891	174.98	4.96	55.35	0.024	-18.90	0.370	-146.16
2.1 GHz	0.891	173.13	4.73	52.95	0.024	-20.38	0.378	-147.46
2.2 GHz	0.892	171.34	4.51	50.59	0.024	-21.80	0.385	-148.75
2.3 GHz	0.892	169.60	4.32	48.25	0.023	-23.16	0.393	-150.03
2.4 GHz	0.892	167.89	4.14	45.95	0.023	-24.48	0.400	-151.32
2.5 GHz	0.892	166.20	3.97	43.66	0.023	-25.74	0.408	-152.61
2.6 GHz	0.893	164.55	3.82	41.40	0.023	-26.95	0.415	-153.91
2.7 GHz	0.893	162.91	3.68	39.16	0.022	-28.11	0.422	-155.21
2.8 GHz	0.893	161.28	3.54	36.93	0.022	-29.22	0.429	-156.52
2.9 GHz	0.893	159.67	3.42	34.72	0.022	-30.28	0.436	-157.84
3.0 GHz	0.894	158.06	3.31	32.52	0.021	-31.28	0.443	-159.17
3.2 GHz	0.894	154.86	3.10	28.16	0.021	-33.13	0.456	-161.87
3.4 GHz	0.894	151.65	2.92	23.83	0.020	-34.76	0.469	-164.62
3.6 GHz	0.895	148.41	2.77	19.52	0.020	-36.15	0.480	-167.42
3.8 GHz	0.895	145.14	2.63	15.23	0.019	-37.28	0.491	-170.27
4.0 GHz	0.895	141.81	2.50	10.94	0.018	-38.13	0.501	-173.18
4.2 GHz	0.895	138.42	2.39	6.64	0.018	-38.69	0.510	-176.16
4.4 GHz	0.896	134.95	2.29	2.32	0.017	-38.93	0.519	-179.20
4.6 GHz	0.896	131.39	2.20	-2.02	0.017	-38.84	0.526	177.68
4.8 GHz	0.896	127.73	2.12	-6.40	0.016	-38.43	0.533	174.48
5.0 GHz	0.895	123.96	2.05	-10.82	0.016	-37.69	0.539	171.19
5.2 GHz	0.895	120.07	1.99	-15.29	0.016	-36.68	0.545	167.80
5.4 GHz	0.895	116.05	1.93	-19.83	0.016	-35.43	0.549	164.31
5.6 GHz	0.895	111.90	1.87	-24.44	0.016	-34.05	0.553	160.70
5.8 GHz	0.895	107.59	1.82	-29.13	0.016	-32.64	0.556	156.95
6.0 GHz	0.895	103.14	1.78	-33.91	0.016	-31.32	0.559	153.06

To download the s-parameters in s2p format, go to the [CGH27030 Product Page](#) and click on the documentation tab.

Product Dimensions CGH27030F (Package Type – 440166)

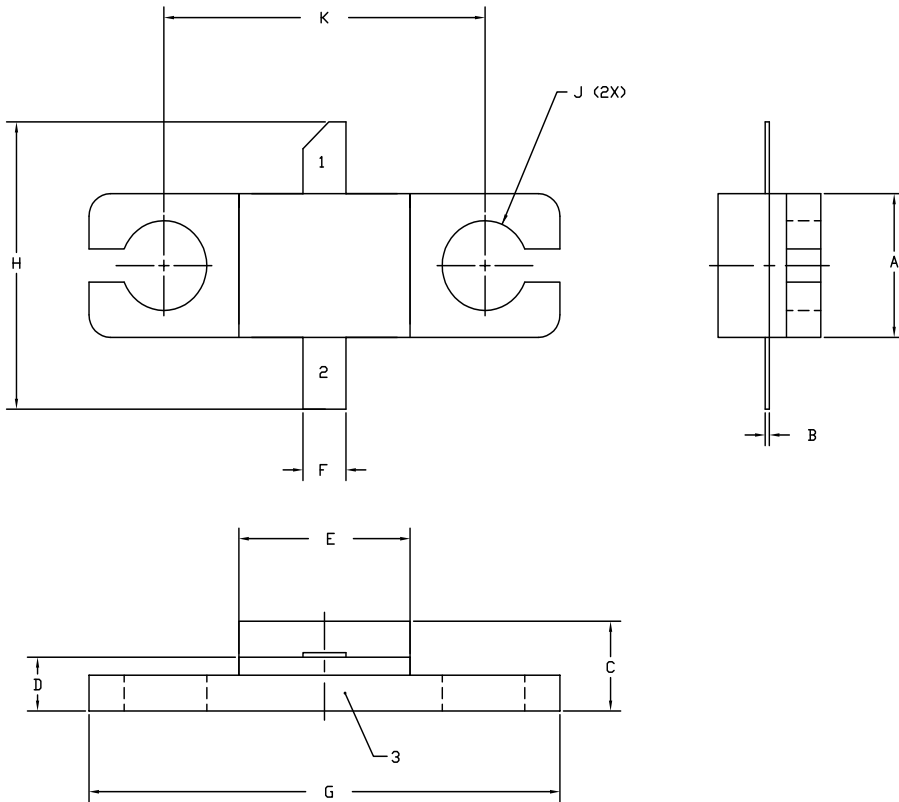

NOTES:

1. DIMENSIONING AND TOLERANCING PER ANSI Y14.5M, 1982.
2. CONTROLLING DIMENSION: INCH.
3. ADHESIVE FROM LID MAY EXTEND A MAXIMUM OF 0.020" BEYOND EDGE OF LID.
4. LID MAY BE MISALIGNED TO THE BODY OF THE PACKAGE BY A MAXIMUM OF 0.008" IN ANY DIRECTION.
5. ALL PLATED SURFACES ARE NI/AU

DIM	INCHES		MILLIMETERS	
	MIN	MAX	MIN	MAX
A	0.155	0.165	3.94	4.19
B	0.004	0.006	0.10	0.15
C	0.115	0.135	2.92	3.43
D	0.057	0.067	1.45	1.70
E	0.195	0.205	4.95	5.21
F	0.045	0.055	1.14	1.40
G	0.545	0.555	13.84	14.09
H	0.280	0.360	7.11	9.14
J	ϕ .100		2.54	
K	0.375		9.53	

- PIN 1. GATE
 PIN 2. DRAIN
 PIN 3. SOURCE

Product Dimensions CGH27030P (Package Type – 440196)

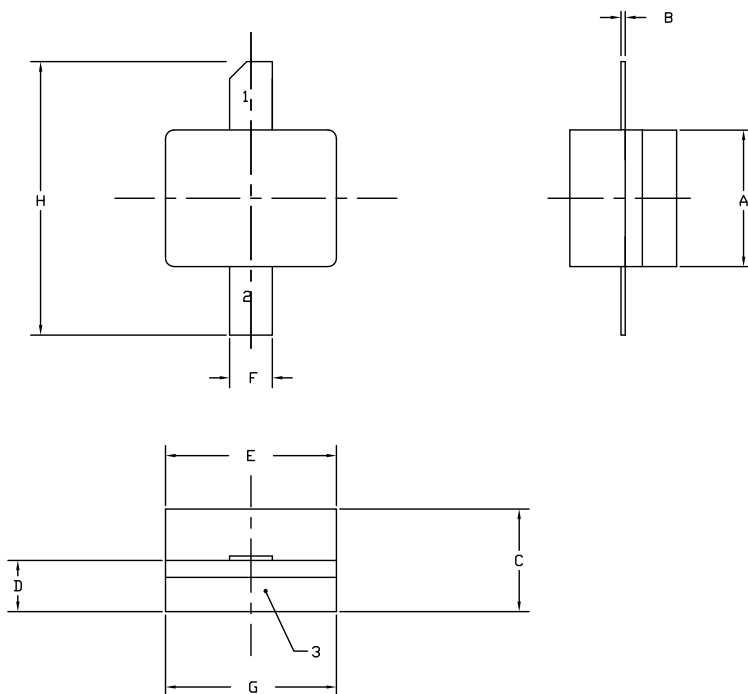



NOTES:

1. DIMENSIONING AND TOLERANCING PER ANSI Y14.5M, 1982.
2. CONTROLLING DIMENSION: INCH.
3. ADHESIVE FROM LID MAY EXTEND A MAXIMUM OF 0.020" BEYOND EDGE OF LID.
4. LID MAY BE MISALIGNED TO THE BODY OF THE PACKAGE BY A MAXIMUM OF 0.008" IN ANY DIRECTION.
5. ALL PLATED SURFACES ARE NI/AU

DIM	INCHES		MILLIMETERS	
	MIN	MAX	MIN	MAX
A	0.155	0.165	3.94	4.19
B	0.003	0.006	0.10	0.15
C	0.115	0.135	2.92	3.17
D	0.057	0.067	1.45	1.70
E	0.195	0.205	4.95	5.21
F	0.045	0.055	1.14	1.40
G	0.195	0.205	4.95	5.21
H	0.280	0.360	7.11	9.14

- PIN 1. GATE
 PIN 2. DRAIN
 PIN 3. SOURCE

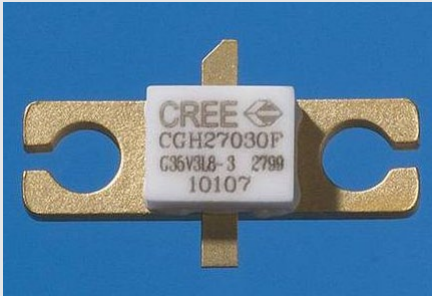
Product Ordering Information

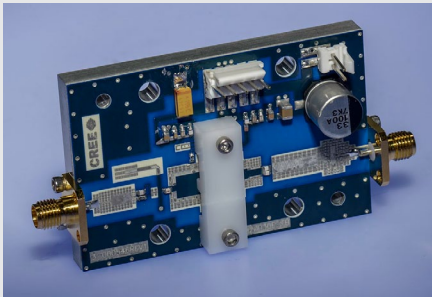
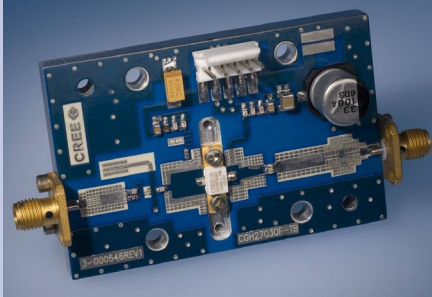
Order Number	Description	Unit of Measure	Image
CGH27030F	GaN HEMT	Each	
CGH27030P	GaN HEMT	Each	
CGH27030F-TB	Test board without GaN HEMT	Each	
CGH27030F-AMP	Test board with GaN HEMT installed	Each	



Disclaimer

Specifications are subject to change without notice. Cree, Inc. believes the information contained within this data sheet to be accurate and reliable. However, no responsibility is assumed by Cree for any infringement of patents or other rights of third parties which may result from its use. No license is granted by implication or otherwise under any patent or patent rights of Cree. Cree makes no warranty, representation or guarantee regarding the suitability of its products for any particular purpose. "Typical" parameters are the average values expected by Cree in large quantities and are provided for information purposes only. These values can and do vary in different applications and actual performance can vary over time. All operating parameters should be validated by customer's technical experts for each application. Cree products are not designed, intended or authorized for use as components in applications intended for surgical implant into the body or to support or sustain life, in applications in which the failure of the Cree product could result in personal injury or death or in applications for planning, construction, maintenance or direct operation of a nuclear facility.

For more information, please contact:

Cree, Inc.
4600 Silicon Drive
Durham, North Carolina, USA 27703
www.cree.com/RF

Sarah Miller
Marketing
Cree, RF Components
1.919.407.5302

Ryan Baker
Marketing & Sales
Cree, RF Components
1.919.407.7816

Tom Dekker
Sales Director
Cree, RF Components
1.919.407.5639