

CMPA2735075D

75 W, 2.7 - 3.5 GHz, GaN MMIC, Power Amplifier

Cree's CMPA2735075D is a gallium nitride (GaN) High Electron Mobility Transistor (HEMT) based monolithic microwave integrated circuit (MMIC). GaN has superior properties compared to silicon or gallium arsenide, including higher breakdown voltage, higher saturated electron drift velocity and higher thermal conductivity. GaN HEMTs also offer greater power density and wider bandwidths compared to Si and GaAs transistors. This MMIC contains a two-stage reactively matched amplifier design approach enabling very wide bandwidths to be achieved.

Typical Performance Over 2.7-3.5 GHz ($T_c = 25^\circ\text{C}$)

Parameter	2.7 GHz	2.9 GHz	3.1 GHz	3.3 GHz	3.5 GHz	Units
Small Signal Gain	28	30	30	29	28	dB
Saturated Output Power, P_{SAT}^1	67	85	101	103	94	W
Power Gain @ P_{SAT}^1	22	24	25	25	24	dB
PAE @ P_{SAT}^1	48	59	61	61	61	%

Note¹: P_{SAT} is defined as the RF output power where the device starts to draw positive gate current in the range of 2-8 mA.

Features

- 28 dB Small Signal Gain
- 80 W Typical P_{SAT}
- Operation up to 28 V
- High Breakdown Voltage
- High Temperature Operation
- Size 0.197 x 0.174 x 0.004 inches

Applications

- Civil and Military Pulsed Radar Amplifiers

Absolute Maximum Ratings (not simultaneous) at 25°C

Parameter	Symbol	Rating	Units
Drain-source Voltage	V_{DS}	84	VDC
Gate-source Voltage	V_{GS}	-10, +2	VDC
Storage Temperature	T_{STG}	-65, +150	°C
Operating Junction Temperature	T_J	225	°C
Thermal Resistance, Junction to Case (packaged) ¹	$R_{\theta JC}$	1.8	°C/W
Mounting Temperature (30 seconds)	T_S	320	°C

Note¹ Eutectic die attach using 80/20 AuSn solder mounted to a 40 mil thick CuW carrier.

Electrical Characteristics (Frequency = 2.7 GHz to 3.5 GHz unless otherwise stated; $T_c = 25^\circ\text{C}$)

Characteristics	Symbol	Min.	Typ.	Max.	Units	Conditions
DC Characteristics						
Gate Threshold Voltage	$V_{GS(TH)}$	-3.8	-3.0	-2.3	V	$V_{DS} = 10\text{ V}, I_D = 28\text{ mA}$
Gate Quiescent Voltage	$V_{GS(Q)}$	-	-2.7	-	V_{DC}	$V_{DD} = 28\text{ V}, I_{DQ} = 800\text{ mA}$, Frequency = 2.9 GHz
Saturated Drain Current ¹	I_{DS}	19.6	27.4	-	A	$V_{DS} = 6.0\text{ V}, V_{GS} = 2.0\text{ V}$
Drain-Source Breakdown Voltage	V_{BD}	84	100	-	V	$V_{GS} = -8\text{ V}, I_D = 28\text{ mA}$
RF Characteristics²						
Small Signal Gain ₁	S21	25	30	-	dB	$V_{DD} = 28\text{ V}, I_{DQ} = 800\text{ mA}$, Frequency = 2.9 GHz
Small Signal Gain ₂	S21	24	28	-	dB	$V_{DD} = 28\text{ V}, I_{DQ} = 800\text{ mA}$, Frequency = 3.5 GHz
Power Output ₁	P_{OUT}	66	85	-	W	$V_{DD} = 28\text{ V}, I_{DQ} = 800\text{ mA}$, $P_{IN} \leq 28\text{ dBm}$, Frequency = 2.9 GHz
Power Output ₂	P_{OUT}	72	94	-	W	$V_{DD} = 28\text{ V}, I_{DQ} = 800\text{ mA}$, $P_{IN} \leq 28\text{ dBm}$, Frequency = 3.5 GHz
Power Added Efficiency ₁	PAE	51	59	-	%	$V_{DD} = 28\text{ V}, I_{DQ} = 800\text{ mA}$, Frequency = 2.9 GHz
Power Added Efficiency ₂	PAE	54	61	-	%	$V_{DD} = 28\text{ V}, I_{DQ} = 800\text{ mA}$, Frequency = 3.5 GHz
Power Gain	G_p	-	24	-	dB	$V_{DD} = 28\text{ V}, I_{DQ} = 800\text{ mA}$
Input Return Loss	S11	-	15	-	dB	$V_{DD} = 28\text{ V}, I_{DQ} = 800\text{ mA}$
Output Return Loss	S22	-	8	-	dB	$V_{DD} = 28\text{ V}, I_{DQ} = 800\text{ mA}$
Output Mismatch Stress	VSWR	-	-	5 : 1	Ψ	No damage at all phase angles, $V_{DD} = 28\text{ V}, I_{DQ} = 800\text{ mA}$, $P_{OUT} = 75\text{ W CW}$

Notes:

¹ Scaled from PCM data.

² All data pulse tested on-wafer with Pulse Width = 10 μs , Duty Cycle = 1%.

Die Dimensions (units in microns)

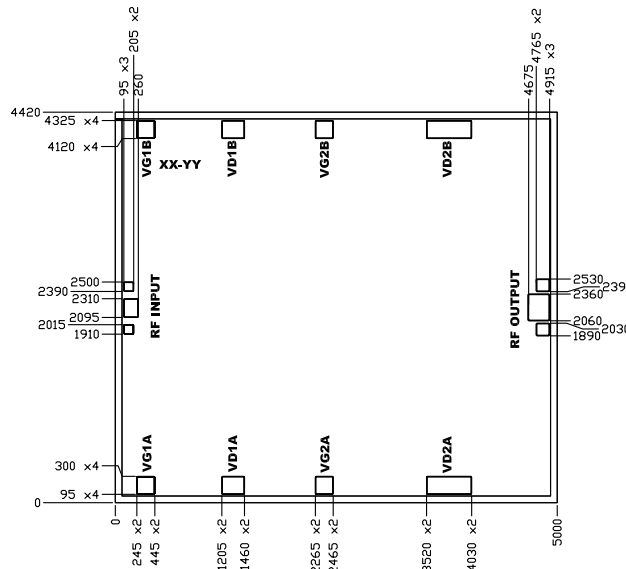

Overall die size 5000 x 4420 (+0/-50) microns, die thickness 100 (+/-10) microns.
All Gate and Drain pads must be wire bonded for electrical connection.

Pad Number	Function	Description	Pad Size (microns)	Note
1	RF-IN	RF-Input pad. Matched to 50 ohm.	150 x 200	3
2	VG1_A	Gate control for stage 1. $V_g \sim 2.0 - 3.5$ V.	200 x 200	1,2
3	VG1_B	Gate control for stage 1. $V_g \sim 2.0 - 3.5$ V.	200 x 200	1,2
4	VD1_A	Drain supply for stage 1. $V_d = 28$ V.	250 x 200	1
5	VD1_B	Drain supply for stage 1. $V_d = 28$ V.	250 x 200	1
6	VG2_A	Gate control for stage 2A. $V_g \sim 2.0 - 3.5$ V.	200 x 200	1
7	VG2_B	Gate control for stage 2B. $V_g \sim 2.0 - 3.5$ V.	200 x 200	1
8	VD2_A	Drain supply for stage 2A. $V_d = 28$ V.	500 x 200	1
9	VD2_B	Drain supply for stage 2B. $V_d = 28$ V.	500 x 200	1
10	RF-Out	RF-Output pad. Matched to 50 ohm.	150 x 200	3

Notes:

¹ Attach bypass capacitor to pads 2-9 per application circuit.

² VG1_A and VG1_B are connected internally so it would be enough to connect either one for proper operation.

³ The RF Input and Output pad have a ground-signal-ground with a nominal pitch of 10 mil (250 μ m). The RF ground pads are 100 x 100.

Die Assembly Notes:

- Recommended solder is AuSn (80/20) solder. Refer to Cree's website for the Eutectic Die Bond Procedure application note at <http://www.cree.com/RF/Document-Library>
- Vacuum collet is the preferred method of pick-up.
- The backside of the die is the Source (ground) contact.
- Die back side gold plating is 5 microns thick minimum.
- Thermosonic ball or wedge bonding are the preferred connection methods.
- Gold wire must be used for connections.
- Use the die label (XX-YY) for correct orientation.

Block Diagram Showing Additional Capacitors & Output Matching Section for Operation Over 2.7 to 3.5 GHz

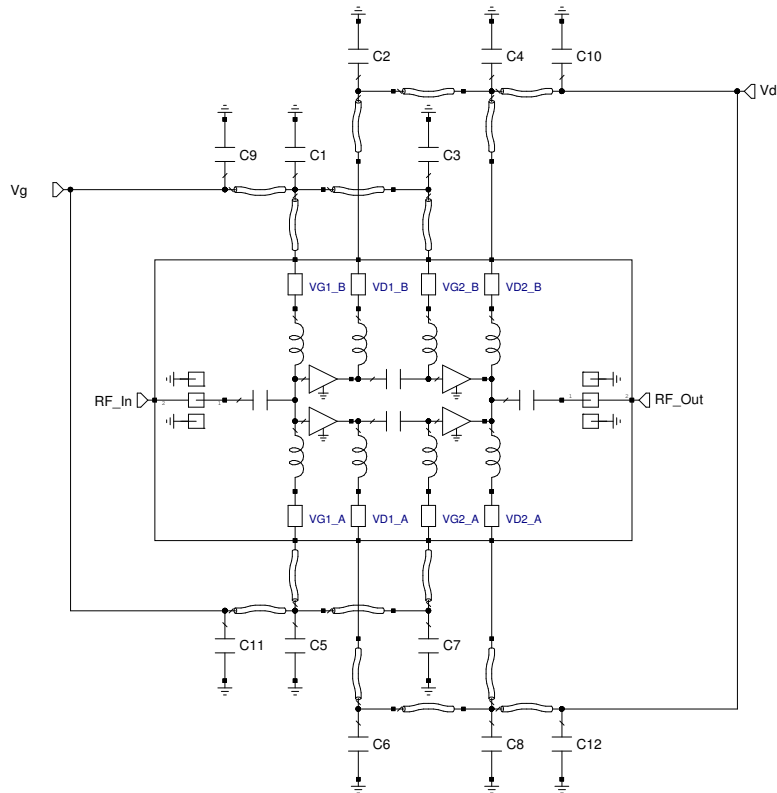

Designator	Description	Quantity
C1,C2,C3,C4,C5,C6,C7,C8	CAP, 120pF, +/-10%, SINGLE LAYER, 0.035", Er 3300, 100V, Ni/Au TERMINATION	8
C9,C10,C11,C12	CAP, 680pF, +/-10%, SINGLE LAYER, 0.070", Er 3300, 100V, Ni/Au TERMINATION	4

Notes:

- ¹ The input, output and decoupling capacitors should be attached as close as possible to the die- typical distance is 5 to 10 mils with a maximum of 15 mils.
- ² The MMIC die and capacitors should be connected with 2 mil gold bond wires.

Typical Performance of the CMPA2735075D

Gain and Input Return Loss vs Frequency
 $V_{DD} = 28\text{ V}, I_{DQ} = 0.7\text{ A}$

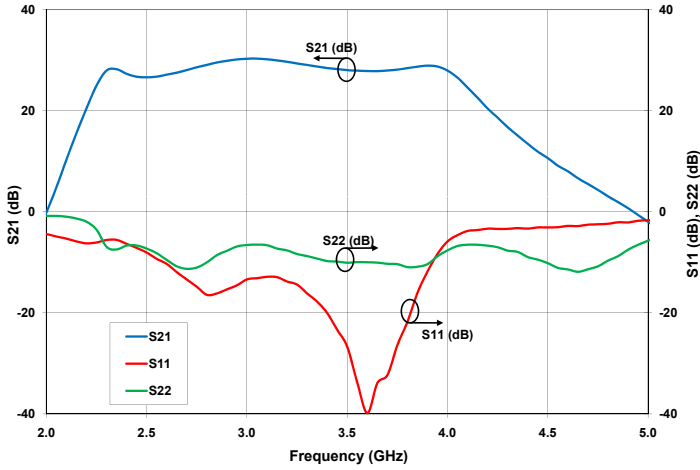

Output Power and Power Added Efficiency vs Frequency
 $V_{DD} = 28\text{ V}, I_{DQ} = 0.7\text{ A}$

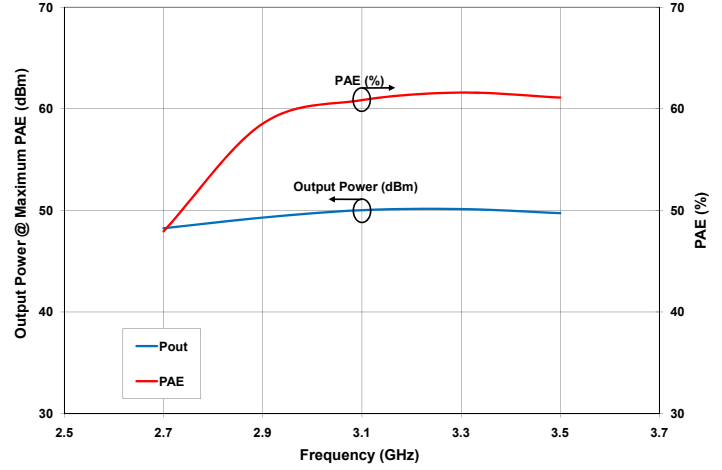

Associated Gain at Maximum Power Added Efficiency vs Frequency
 $V_{DD} = 28\text{ V}, I_{DQ} = 0.7\text{ A}$

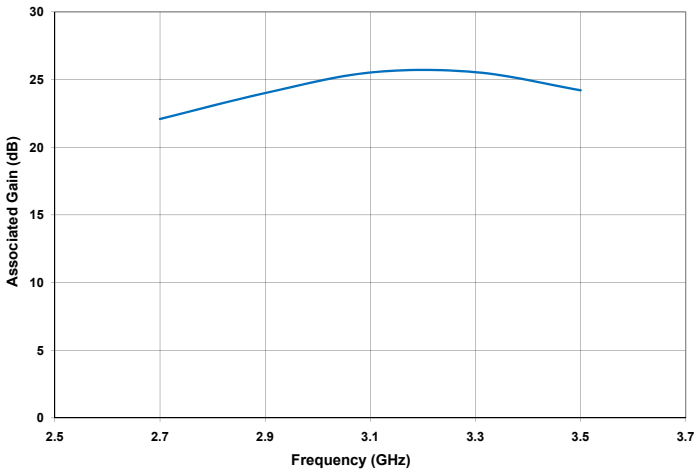

Gain and Power Added Efficiency vs Output Power
 $V_{DD} = 28\text{ V}, I_{DQ} = 0.7\text{ A}, \text{Frequency} = 3.1\text{ GHz}$

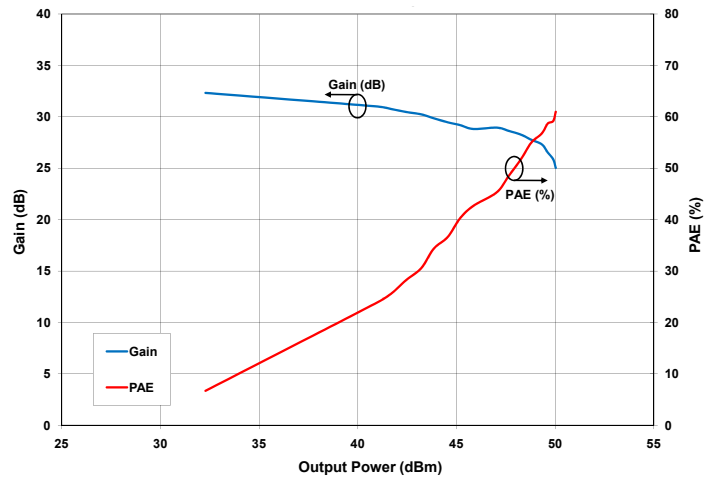

CMPA2735075D

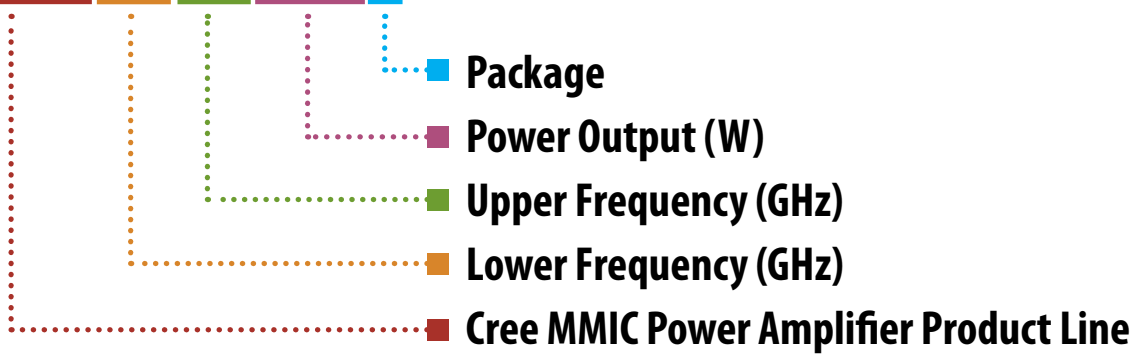

Parameter	Value	Units
Lower Frequency	2.7	GHz
Upper Frequency	3.5	GHz
Power Output	75	W
Package	Bare Die	-

Table 1.

Note: Alpha characters used in frequency code indicate a value greater than 9.9 GHz. See Table 2 for value.

Character Code	Code Value
A	0
B	1
C	2
D	3
E	4
F	5
G	6
H	7
J	8
K	9
Examples:	1A = 10.0 GHz 2H = 27.0 GHz

Table 2.



Product Ordering Information

Order Number	Description	Unit of Measure
CMPA2735075D	GaN MMIC Power Amplifier Bare Die	Each



Disclaimer

Specifications are subject to change without notice. Cree, Inc. believes the information contained within this data sheet to be accurate and reliable. However, no responsibility is assumed by Cree for its use or for any infringement of patents or other rights of third parties which may result from its use. No license is granted by implication or otherwise under any patent or patent rights of Cree. Cree makes no warranty, representation or guarantee regarding the suitability of its products for any particular purpose. "Typical" parameters are the average values expected by Cree in large quantities and are provided for information purposes only. These values can and do vary in different applications, and actual performance can vary over time. All operating parameters should be validated by customer's technical experts for each application. Cree products are not designed, intended, or authorized for use as components in applications intended for surgical implant into the body or to support or sustain life, in applications in which the failure of the Cree product could result in personal injury or death, or in applications for the planning, construction, maintenance or direct operation of a nuclear facility. CREE and the CREE logo are registered trademarks of Cree, Inc.

For more information, please contact:

Cree, Inc.
4600 Silicon Drive
Durham, North Carolina, USA 27703
www.cree.com/RF

Sarah Miller
Marketing
Cree, RF Components
1.919.407.5302

Ryan Baker
Marketing & Sales
Cree, RF Components
1.919.407.7816

Tom Dekker
Sales Director
Cree, RF Components
1.919.407.5639