

# High Efficiency, High Linearity GaN HEMT Amplifiers for WiMAX Applications

U. H. Andre, R. S. Pengelly, A. R. Prejs and S. M. Wood, Cree Inc., and  
E. J. Crescenzi, Central Coast Microwave Design LLC

Here are several WiMAX amplifier designs delivering from two to ten watts OFDM power, using various devices in a family of GaN HEMT transistors recently developed by Cree Inc.

**G**aN HEMT power transistors are a key enabling technology for the successful design of WiMAX, WiBro and next generation radio systems. This article describes the design and performance of a

number of demonstration amplifiers using Cree GaN HEMTs, including a Doherty circuit providing the highest reported performance for a WiMAX power amplifier.

## Introduction

Many fixed and mobile WiMAX equipment vendors are now investigating ways to make base-stations smaller and more energy-efficient. The power amplifiers in these base-stations dictate the performance of the equipment. Higher efficiency amplifiers enable a number of benefits for base-station equipment such as smaller physical size, reduced weight, greater DC to RF conversion efficiency as well as the ability to move closer to becoming maintenance-free. The improved efficiency of such amplifiers also makes it possible to lower the cost of other base station equipment, such as power supplies and air-conditioners and reduce noise impact (smaller or no fans).

Using its gallium-nitride (GaN) HEMT device technology Cree has developed a number of discrete transistors and demonstration amplifiers covering many of the operational frequency bands for WiMAX including 2.5 GHz and 3.5 GHz. The design of the demonstration amplifier circuits includes the need to provide higher efficiencies compared to other technologies such as GaAs MESFET and



Figure 1(a) - Photograph of CGH35015S plastic molded WiMAX transistor.

LDMOS FETs as well as providing reference designs that are more manufacturable when compared to other transistor technologies. The latter is due to the fact that GaN HEMTs provide intrinsically wider bandwidth operation. These amplifier circuits have also taken into account the additional performance improvements that can be produced using digital pre-distortion technology that already has a proven track record in 3G systems. The amplifiers exhibit excellent linearity over a wide dynamic range both for EVM (RCE) as well as compliance to relevant spectral emission masks (SEMs).

This article describes the application of a family of Cree GaN HEMT WiMAX transistors in a number of amplifier designs providing average OFDM output powers in the range from 2 to 10 watts. The design examples all employ over-molded plastic surface mount packaged transistors. Average drain efficiencies in the 22 to 25% range have been demonstrated. A compact Doherty amplifier

Product Name	Band (GHz)	Gain (dB)	Efficiency (%)	Average Power (W)	Package Type
CGH27015	2.3-2.9	14.0	27.0	2.5	Flange or SMT
CGH35015	3.3-3.9	12.5	25.0	2.5	Flange or SMT
CGH27030	2.3-2.9	12.5	26.0	5	Flange or SMT
CGH35030	3.3-3.9	11.0	24.0 </td <td>5</td> <td>Flange or SMT</td>	5	Flange or SMT

Table 1 · Part of the Cree WiMAX transistor family.

reference design, employing flange mounted transistors, is also described, which has achieved state-of-the-art drain efficiencies close to 45% with OFDM signals with 10 dB PAR's at average output powers of greater than 10 watts at 3.5 GHz. A two-stage amplifier with over 23 dB gain has achieved efficiencies of greater than 30% and is suitable for digital pre-distortion correction. These efficiencies represent a two to three times improvement when compared to conventional amplifiers. The development of these prototype amplifiers paves the way for the practical use of GaN HEMT-based high-efficiency amplifiers in both fixed and mobile IEEE 802.11d-2004 and 802.11e-2005 equipment applications.

**Amplifier Designs using Large Signal Models**

Part of the Cree WiMAX transistor family is shown in Table 1 and covers a range of average powers from 2 to 5 watts over the frequency

range 2.3 GHz to 3.9 GHz. This article will specifically cover the design of four GaN HEMT based amplifiers, three using plastic over-molded transistors (CGH27015S, 35015S and 35030S) and one using a ceramic/metal packaged transistor—the CGH35030F.

The first three amplifiers are designed to have drain efficiencies at their relevant backed-off power points of greater than 20%. The fourth design is a 2-way Doherty amplifier designed to have a drain efficiency of greater than 40% at its back-off power point.

All the designs described in this article have employed Cree's proprietary large-signal models that currently support Agilent's Advanced Design System and AWR's Microwave Office simulators. These models include complete package parasitics, are broadband so that harmonic terminations can be considered in designs, allow working transistor junction temperatures to be included, and allow the simulation of

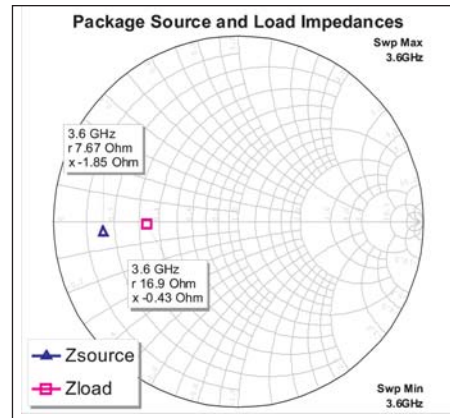

Figure 1(b): CGH35015S packaged source and load impedances.

two-tone intermodulation products. The latter, by comparing measured IMDs to EVM, allow a good estimate of amplifier linearity under OFDM modulation.

**CGH35015S-Based Amplifier Design**

The CGH35015S employs an unmatched GaN HEMT in a small, overmolded plastic QFN package, which is 3 × 3 mm [1]. This package is electrically small and allows the device to be employed successfully in designs in excess of 5 GHz. A photograph of a 3 × 3 mm QFN is shown in Figure 1(a). The HEMT is nominally operated at a rail voltage of 28 volts and a quiescent drain current,  $I_{DQ}$ , of 60 mA in Class A/B. The simulated source and load impedances of the plastic packaged transistor are

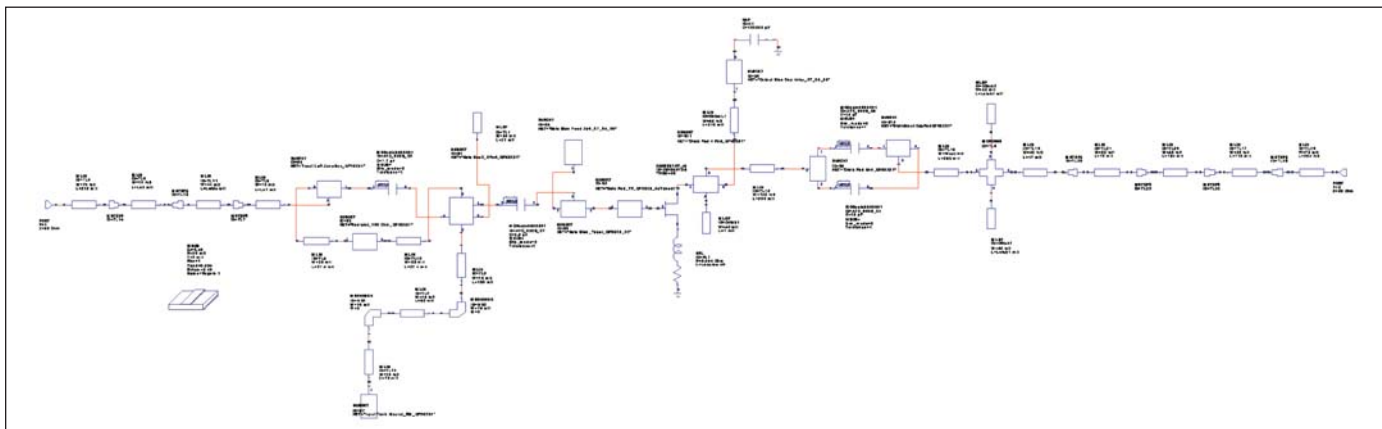

Figure 2 · Schematic of CGH35015S amplifier.

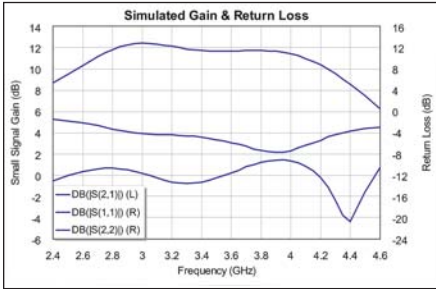

Figure 3 · Simulation of the small signal gain and return loss.

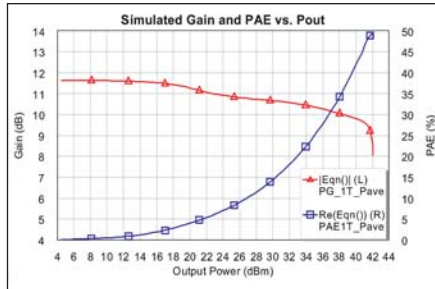

Figure 4 · Simulated gain and efficiency of the amplifier at 3.6 GHz.

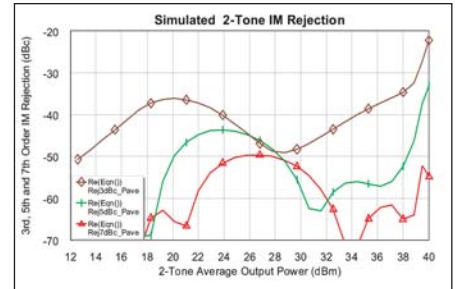

Figure 5 · Simulated IM3, 5, and 7 vs two-tone average output power.

shown in Figure 1(b) at 3.6 GHz. As can be seen the output load impedance, in particular, is quite convenient for matching to 50 ohms.

Because the gain of the GaN HEMTs is large at low frequencies, care is taken to include some stabilization circuits on the input of the amplifier. Also, the distributed matching used on the input of the amplifier allows some flexibility in tuning for best performance in terms of gain, bandwidth and linearity. The full circuit schematic is shown in Figure 2. Figure 3 shows the simulated small signal gain and input return loss of the amplifier over 2.4 to 4.6 GHz. Note that the amplifier design is able to cover the full 3.3 to 3.9 GHz WiMAX band.

The output network, which again uses distributed elements, is designed to achieve acceptable IM3, IM5 and IM7 products, while simultaneously providing the required efficiency and gain. Note that the compression characteristics of the GaN HEMT are quite soft until  $P_{SAT}$  is

reached. This is advantageous as it allows the peaks of the OFDM signal to be reproduced adequately even though the  $P_{1dB}$  gain compressed power is considerably lower than  $P_{SAT}$ . Figure 4 shows the simulated gain and efficiency of the complete amplifier as a function of single-tone CW output power.

Note that at the backed-off power point of 2 watts the amplifier has a single tone efficiency of 20%. Also, Figure 5 shows the simulated IM3, 5 and 7 as a function of two-tone average output power (where the tone spacing is 5 MHz). Note that there is a relatively shallow “sweet spot” around 1 to 2 watts of average power and that there is also a backed-off power “IMD hill,” which has been reduced to below  $-35$  dBc to assure that EVM in back-off is also at an acceptable level.

Figure 6 shows a photograph of the complete amplifier that uses Rogers 4350 printed circuit board with a dielectric constant of 3.48 and a thickness of 20 mil. The design not

only required accurate modeling of the surface mount package but also the “via farm” in the PCB immediately beneath the transistor package. The practical performance of this plastic surface mount transistor based amplifier is superior to the flanged package version (CGH35015F) because the plastic package affords lower parasitics and shorter electrical lengths.

### Measured Results of the CGH35015S Amplifier

Figure 7 shows the measured small signal gain and input return loss of the amplifier over 2.5 to 4.5 GHz. Gain is maintained at 13 to 14 dB and return loss is maintained at  $-10$  to  $-12$  dB over 3.0 to 4.0 GHz. Figure 8 shows typical single tone CW gain and drain efficiency as a function of output power. Note that at 2 watts output power the drain efficiency is 20%—matching the simulated results using the large-signal model.

A typical RMS error vector magnitude (EVM) and efficiency plot taken under 802.16-2004 OFDM (3.5 MHz



Figure 6 · Photograph of a demonstration amplifier using the CGH35015S .

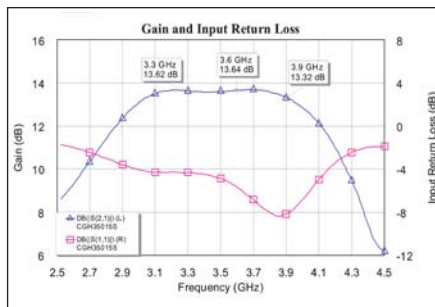

Figure 7 · Measured gain and input return loss of CGH35015S demonstration amplifier.

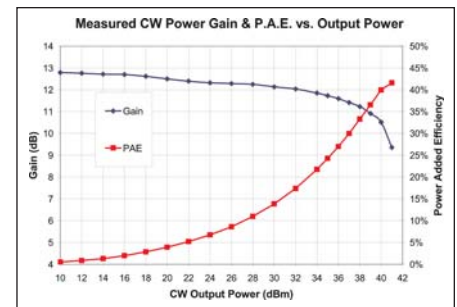

Figure 8 · Measured CW gain and PAE of the CGH35015S demonstration amplifier.



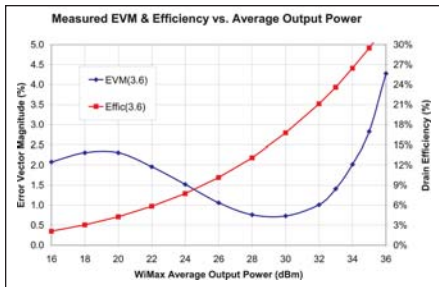

Figure 9(a) · Measured EVM and efficiency as a function of output power at 3.6 GHz.

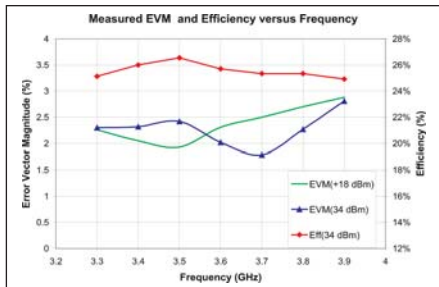

Figure 9(b) · Measured EVM and efficiency as a function of frequency at 2.5 W.

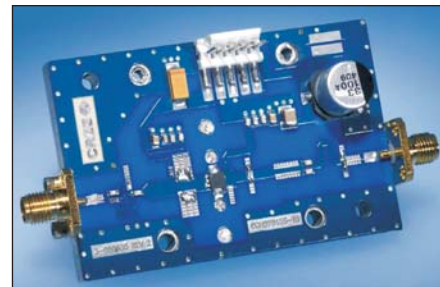

Figure 10(b) · Photograph of CGH27015S demonstration amplifier.

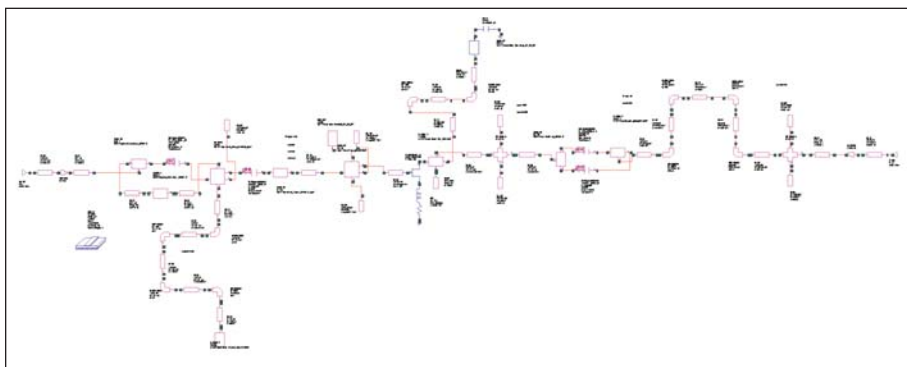

Figure 10(a) · Schematic of CGH27015S amplifier.

Channel BW, 1/4 cyclic prefix, 64 QAM modulated burst, symbol length of 59, coding type RS-CC, coding rate type 2/3 at 3.6 GHz is shown in Figure 9(a). At 2 watts average output power (at <2% EVM) the drain efficiency is 24%—very close to the simulated results using the large-signal model. Figure 9(b) shows typical EVM at average powers of 18 and 34 dBm and drain efficiency at 34 dBm as a function of frequency over 3.3 to 3.9 GHz.

### CGH27015S-Based Amplifier

The design sequence for a 2.3 to 2.9 GHz WiMAX amplifier employing the CGH27015S plastic surface mount transistor is very similar to the one previously described. The full schematic for the amplifier is shown in Figure 10(a) with a corresponding photograph of the printed circuit board in Figure 10(b).

Gain, shown in Figure 11(a), is maintained at approximately 15 dB from 2.3 to 2.7 GHz. Figure 11(b)

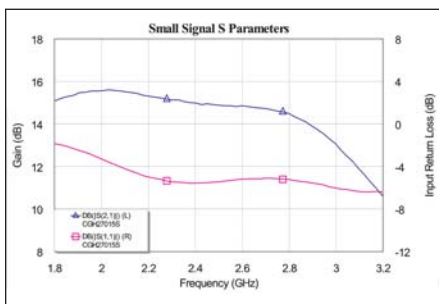

Figure 11(a) · Measured gain and return loss of the CGH27015S WiMAX amplifier.

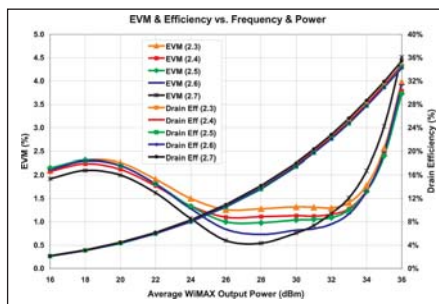

Figure 11(b) · Measured EVM and efficiency as a function of WiMAX output power.

shows the EVM and drain efficiency as a function of frequency from 2.3 to 2.7 GHz. At 2% EVM the average output power is 2.5 watts with a drain efficiency of 28%. We believe this is the best-reported drain efficiency for a WiMAX amplifier in this band to date.

### CGH35030S-Based Amplifier

A demonstration amplifier employing the 4 × 4 mm QFN plastic packaged CGH35030S transistor will now be described. This transistor is capable of providing 4 watts of average OFDM power at less than 2.0% EVM. The power level of this surface mountable device dictated the need for much greater attention to detail in both modeling of the package parasitics and the circuit layout. The wire-bonds and transitions through the package were inspected using the 3-D view of the layout, as shown in Figure 12. The transitions were modeled using the planar EM simulator and the wire-bonds used a model that takes into account the overmolded plastic of the package. This model has been successfully used to generate valid S-parameters up to 6 GHz.

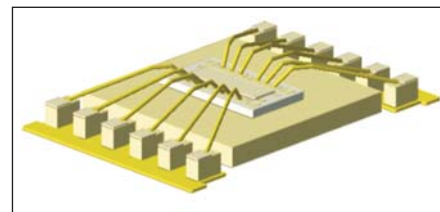

Figure 12 · 3-D view of package model for CGH35030S.

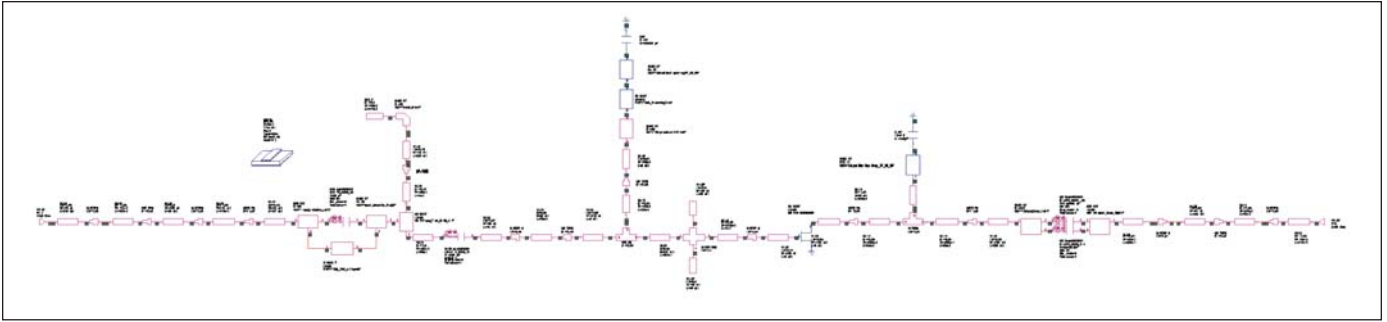

Figure 13a · Schematic of CGH35030S-based amplifier.

The design flow was very similar to that of the 15 W devices described earlier. The networks were derived from source and load-pull of the large signal packaged device model. The reference circuit for the CGH35030S was designed to cover the core WiMAX frequencies of 3.3 GHz to 3.7 GHz. When designing the input and output networks great care was taken to ensure that there were no reference plane errors; this was done by generating the layout directly from the schematic. The full amplifier schematics can be seen in Figure 13(a) with its associated layout in Figure 13(b).

The benefit of carefully managing the schematic and layout design can be seen with the excellent correlation of simulated and measured gain and input return loss as shown in Figure 14. It can be seen that the gain is maintained above 11.5 dB from 3.2 GHz to 3.7 GHz. The linearity results of the CGH35030S demonstration amplifier are also provided in Figure 15. The demonstration amplifier has

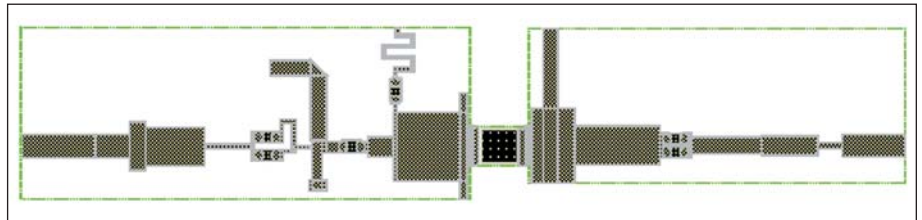

Figure 13b · Layout view of CGH35030S-based amplifier.

EVM better than 2% over a 15 dB dynamic range up to 4 watts over 3.4-3.7 GHz. The drain efficiency at 5 W average output power is 24% with an associated EVM of 2.4%. A photograph of the finished demonstration circuit is shown in Figure 16.

**Thermal and Electrical Design Considerations for Surface Mount Packages**

Since the average RF powers delivered by the CGH27015S, 35015S or 35030S are 2 or 4 watts respectively at drain efficiencies of 22% or so, the dissipated average powers are 7 and 14 watts respectively. The measured thermal resistances of the two

types of transistor are 7°C/watt and 5°C/watt respectively. This measurement is performed where the QFN packages are soldered to a 20 mil thick PCB with the via-hole arrangement shown in Figure 17. The case temperature is defined as the bottom of the ground paddle of the QFN package. The CGH27015/35015S devices, therefore, will be operating with transistor junction temperatures of 134°C at case temperatures of 85°C. The CGH35030S operates at a junction temperature of 155°C at a case temperature of 85°C. For both products the junction temperatures are within the safe operating limits of the devices. It is also important to

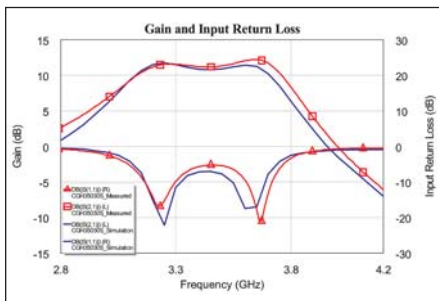

Figure 14 · Modeled and measured gain and input return loss for CGH35030S-based amplifier.

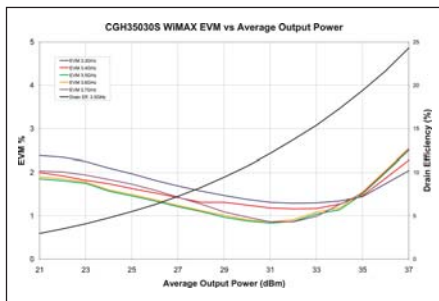
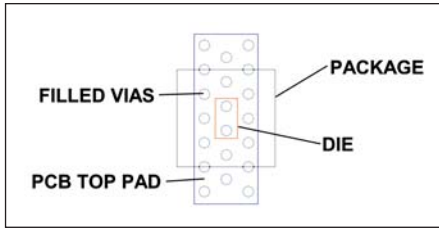

Figure 15 · Measured WiMAX EVM vs average output power for CGH35030S-based amplifier.



Figure 16 · Photograph of the CGH35030S-based amplifier.



**Figure 17 . Printed circuit board via array for device grounding and thermal sinking.**

take into consideration the electrical effect of the via array. This was simulated by using a simple approximation of the array as a set of vias with interconnecting microstrip lines. The schematic associated with the via layout of Figure 17 is shown in Figure 18. The associated inductance from this array of vias was found to be approximately 30 pH.

### **A Doherty Amplifier using the CGH35030F**

The Doherty amplifier has seen a resurgence in its popularity in the past few years [2, 3, 4] as a means to providing enhanced efficiencies in applications where signals using peak to average ratios of around 7 to 8 dB (W-CDMA) are employed. Doherty amplifiers to date using LDMOS FETs and GaAs MESFETs/pHEMTs have tended to be rather narrow band as well as being a challenge in repeatability in volume manufacture. GaN HEMTs having higher power densities and lower output capacitances together with lower changes in output capacitance as a function of drain voltage offer more “ideal” transistors for the carrier and peaking amplifiers in a Doherty arrangement.

The Doherty amplifier circuit uses two CGH35030F GaN HEMT transistors that improve backed-off efficiency under high peak to average modulation, such as OFDM. This section of the article describes the typical performance that has been achieved under an available 802.16-2004 modulation.

The 2-way asymmetric Doherty

amplifier has 300 MHz instantaneous bandwidth centered at 3.55 GHz with a small signal gain of 11 dB. The amplifier displays 49% efficiency at 12.5 W of average OFDM power and is suitable for both WiMAX fixed access (802.16-2004 OFDM) and WiMAX mobile access (802.16e-2005 OFDM) applications. The design is intended specifically to

be used with pre-distortion components to achieve EVM and SEM compliances. A photograph of the amplifier is shown in Figure 19.

The amplifier consists of an input power splitter (unequal division) integrated with appropriate delay lines and two amplifiers (Carrier and Peaking branches) and then the necessary combining output circuitry.



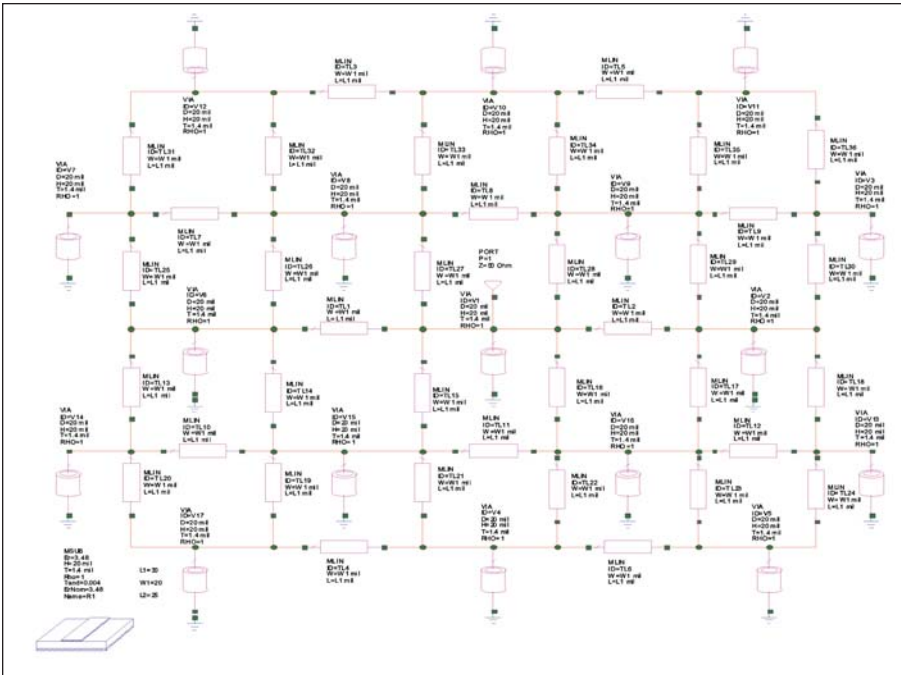

Figure 18 · Schematic of via array for thermal sinking and electrical grounding for the CGH35030S.

The principal of operation involves a “carrier amplifier” that provides the gain at low signal levels, and a “peaking amplifier” that is biased Class C and becomes active only with high input signal levels. As the peaking amplifier turns on, it adjusts the

dynamic load conditions presented to the main amplifier. The result is an amplifier that has a very low quiescent bias current, similar to a 30 W Class AB amplifier, but with peak output power capability equivalent to a 60 W amplifier. The asymmetrical

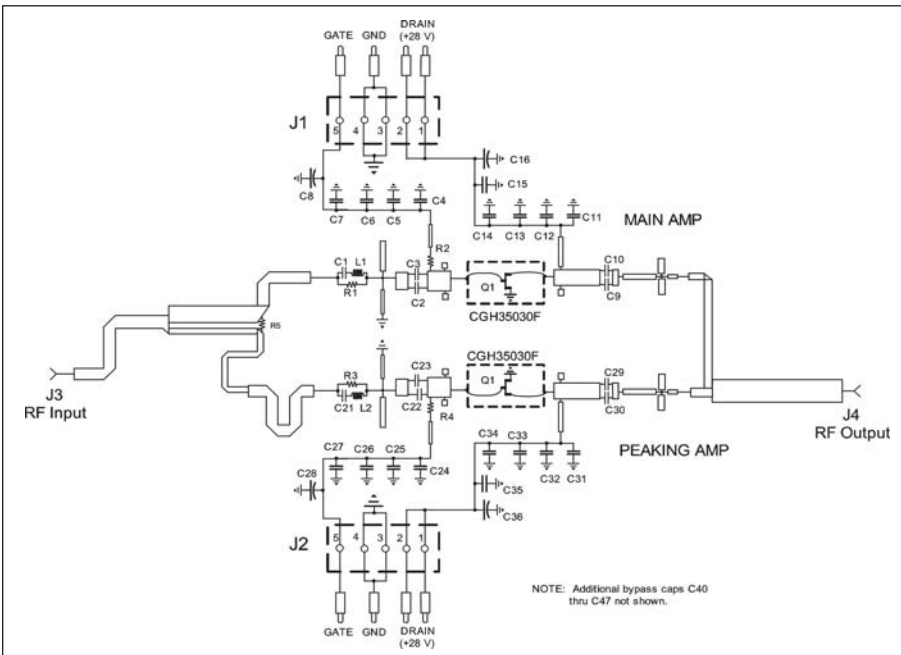

Figure 20 · Schematic of Doherty amplifier.

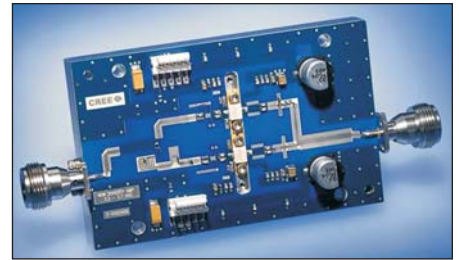

Figure 19 · Photograph of the Doherty amplifier using the CGH35030F device.

input power division helps to improve gain and efficiency when compared to a “classical” equal split two-way Doherty architecture [5]. A schematic of the amplifier is shown in Figure 20.

### Performance of Doherty Amplifier

Figure 21 shows the small-signal gain and input return loss of the Doherty amplifier as a function of frequency. The peaking amplifier quiescent drain current was adjusted for lowest error vector magnitude (EVM) at an average output power under OFDM (with a PAR of 9.8 dB) of 10 watts. This is shown in Figure 22 where it can be seen that an EVM of less than 5% is produced with a corresponding drain efficiency of 45%. Figure 23 shows the EVM and efficiency of the amplifier as a function of average output power over a 22 dB dynamic range.

Figure 24 shows the so-called ETSI Type G (offsets C and D) spectral emissions as a function of output power. The specification for Offset D is 38 dBc—a single ended

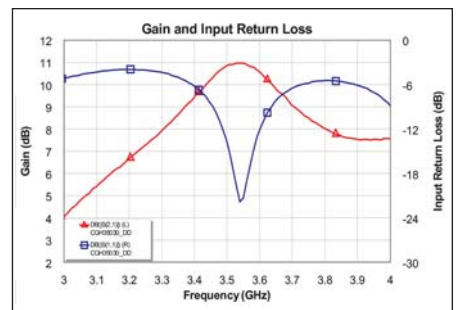

Figure 21: Small signal gain and input return loss of the Doherty amplifier.

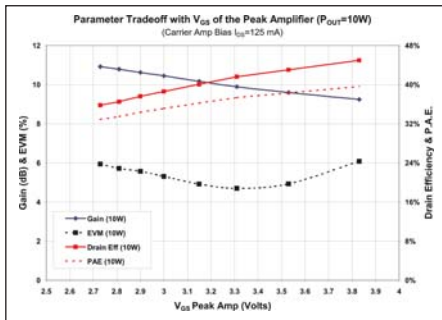

Figure 22 · Gain, EVM and efficiency versus peaking amplifier gate-to-source bias voltage.

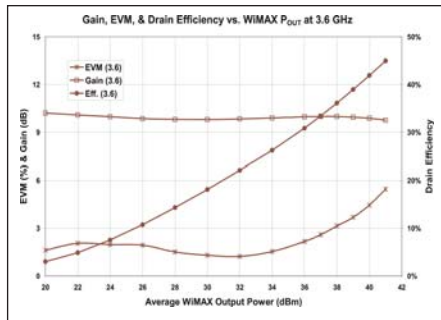

Figure 23 · Gain, EVM and efficiency at 3.6 GHz versus  $P_{AVE}$ .

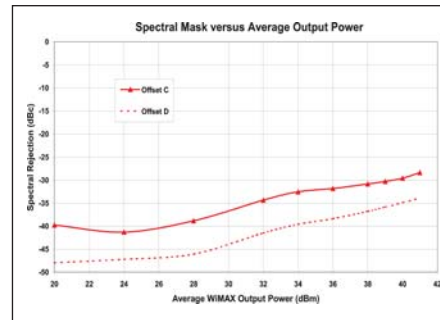

Figure 24 · Measured offset C and D levels to Type G ETSI spectral emissions mask.

CGH35030F based WiMAX amplifier would typically be in the 42 dBc range and the Doherty amplifier degrades this to approximately 35 dBc. Again, the Doherty amplifier is designed specifically for best efficiency and gain with the assumption that pre-distortion correction or other means will restore acceptable linearity and spectral emissions.

The Doherty amplifier has also been cascaded with a CGH35015S amplifier acting as a driver stage. Overall gain at 3.5 GHz was 23 dB with an overall PAE of 33%.

### Digital Predistortion of The Doherty Amplifier

Digital predistortion (DPD) is an efficient, cost-effective means of compensating for power amplifier nonlinearity. In many cases the DPD design implements an adaptive lookup table (LUT)-based algorithm (Figure 25 and [6]). The design constantly applies correction values from a LUT to the incoming stream of samples. It

also compares the measured output with the input, and uses this measurement to update the LUT, making the system adaptive. For CDMA-based modulation architectures crest factor reduction (CFR) has also been applied to reduce the effective PAR of the signals making the DPD tasks easier. Compared to CDMA/W-CDMA systems with PARs of around 6 to 7 dB, OFDM PAR's can be as high as 13 dB and algorithms are still being developed for effective CFR.

Initial investigations of applying digital pre-distortion with memory correction to the above Doherty amplifier have been conducted by third-parties. For example, using a 10 MHz bandwidth WiMAX signal at 3.5 GHz with a PAR of 7 dB and  $P_{AVE}$  of 10 watts has resulted in 1 and 3 MHz offset spectral emissions of -64 dBc/MHz and -66 dBc/MHz respectively. The requirements at 3.4 to 3.6 GHz are -59 dBc/MHz and -62 dBc/MHz respectively. Thus, the Doherty amplifier with DPD is able

to meet the requirements with sufficient margin to enable compliant performance over operating conditions while maintaining exceptionally high efficiency.

### Conclusions

This article has discussed a number of power amplifier design examples for WiMAX applications in the 2.5 and 3.5 GHz bands. All designs utilized Cree's GaN HEMT transistors and were designed using Cree's large signal models that are available for all of these devices. A realization of a Doherty amplifier was also shown using two CGH35030F transistors that has demonstrated state-of-the-art efficiency at acceptable linearity once corrected with a digital pre-distortion architecture.

### References

1. E. J. Crescenzi, Jr., S. M. Wood, A. Prejs, R. S. Pengelly, W. Pribble, "A 2.5 Watt 3.3-3.9 GHz Power Amplifier for WiMAX Applications using a GaN HEMT in a Small Surface-Mount Package," IEEE Interactive Forum WEPIF-04, IMS2007.
2. S. M. Wood, R. S. Pengelly and M. Suto, "A High Power, High Efficiency UMTS Amplifier using a Novel Doherty Configuration," IEEE Topical Workshop on Power Amplifiers for Wireless Communications, 2003.
3. J. Gajadharsing, O. Bosma, and P. van Western, "Analysis and design

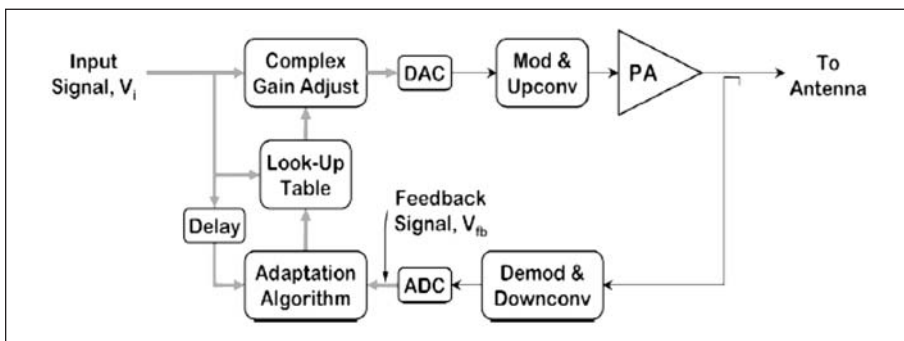

Figure 25 · Digital predistortion block diagram.



of a 200 W LDMOS based Doherty amplifier for 3-G base station," *IEEE MTT-S International Microwave Symposium Digest*, 2004, pp. 529-532.

4. J. Kim, J. Cha, I. Kim, and B. Kim, "Optimum operation of asymmetrical cell-based linear Doherty power amplifiers-Uneven power drive and power matching," *IEEE Trans. Microwave Theory and Techniques*, 53, No. 5, May 2005, pp. 1802-1809.

5. R.S. Pengelly and S.M. Wood, "N-way RF power amplifier circuit with increased back-off capability and power added efficiency using unequal input power division," US Patent #6,737,922.

6. K. Mekechuk, Wan-Jong Kim, S.P. Stapleton and Jong Heon Kim, "Linearizing Power Amplifiers Using Digital Predistortion, EDA Tools and Test Hardware," *High Frequency Electronics*, April 2004, p. 18.

#### Author Information

Ulf H. Andre received the M.Sc

Degree in Electrical Engineering in 1992 from Royal Institute of Technology, Stockholm, Sweden. He joined Cree in October 2006 and is currently working with device development and reference designs for WiMAX applications.

Jim Crescenzi received the BS degree at UC Berkeley in 1961 and the MS and PhD degrees at the University of Colorado in 1962 and 1969. He founded Central Coast Microwave Design in 2005, where he provides consulting services primarily for microwave power amplifiers and subsystems. He can be reached at [jcrescenzi@charter.net](mailto:jcrescenzi@charter.net).

Ray Pengelly gained his BSc and MSc degrees from Southampton University, England in 1969 and 1973 respectively. Since 1999, Ray has been employed by Cree Inc. He is presently responsible for the business development of RF and wireless products and applications using SiC MESFET and GaN HEMT devices.

He can be reached by email at [ray\\_pengelly@cree.com](mailto:ray_pengelly@cree.com).

Art Prejs graduated from Lehigh University in 1997 with a BS Degree in Mechanical Engineering. Since 2006, Art has been employed at Cree Inc. and is responsible for package development, characterization and reliability activities .

Simon Wood graduated from the University of Bradford, England in 1995 with a degree in Electronic Engineering with European Studies. Since 2000 he has been employed with Cree Inc, where he is currently Manager of RF Product Development.

#### For further information, contact:

**Tom Dekker,**  
**Cree, Inc.,**  
**3026 E. Cornwallis Road,**  
**Research Triangle Park, NC 27709**  
**Tel: 919-313-5639**  
**[www.cree.com](http://www.cree.com)**

---