

# C3M0120100J

## Silicon Carbide Power MOSFET

### C3M™ MOSFET Technology

#### N-Channel Enhancement Mode

#### Features

- C3M™ SiC MOSFET technology
- Low parasitic inductance with separate driver source pin
- 7mm of creepage distance between drain and source
- High blocking voltage with low On-resistance
- Fast intrinsic diode with low reverse recovery (Qrr)
- Low output capacitance (60pF)
- Halogen free, RoHS compliant

#### Benefits

- Reduce switching losses and minimize gate ringing
- Higher system efficiency
- Reduce cooling requirements
- Increase power density
- Increase system switching frequency

#### Applications

- Renewable energy
- EV battery chargers
- High voltage DC/DC converters
- Switch Mode Power Supplies

$V_{DS}$	1000 V
$I_D @ 25^\circ\text{C}$	22 A
$R_{DS(on)}$	120 mΩ

#### Package

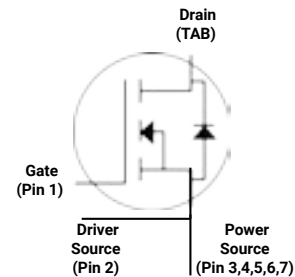

Part Number	Package	Marking
C3M0120100J	TO-263-7	C3M0120100J

#### Maximum Ratings ( $T_C = 25^\circ\text{C}$ unless otherwise specified)

Symbol	Parameter	Value	Unit	Test Conditions	Note
$V_{DSmax}$	Drain - Source Voltage	1000	V	$V_{GS} = 0\text{ V}, I_D = 100\ \mu\text{A}$	
$V_{GSmax}$	Gate - Source Voltage (dynamic)	-8/+19	V	AC ( $f > 1\text{ Hz}$ )	Note: 1
$V_{GSop}$	Gate - Source Voltage (static)	-4/+15	V	Static	Note: 2
$I_D$	Continuous Drain Current	22	A	$V_{GS} = 15\text{ V}, T_C = 25^\circ\text{C}$	Fig. 19
		13.5		$V_{GS} = 15\text{ V}, T_C = 100^\circ\text{C}$	
$I_{D(pulse)}$	Pulsed Drain Current	50	A	Pulse width $t_p$ limited by $T_{jmax}$	Fig. 22
$P_D$	Power Dissipation	83	W	$T_C = 25^\circ\text{C}, T_J = 150^\circ\text{C}$	Fig. 20
$T_J, T_{stg}$	Operating Junction and Storage Temperature	-55 to +150	$^\circ\text{C}$		
$T_L$	Solder Temperature	260	$^\circ\text{C}$	1.6mm (0.063") from case for 10s	

Note (1): When using MOSFET Body Diode  $V_{GSmax} = -4\text{V}/+19\text{V}$

Note (2): MOSFET can also safely operate at  $0/+15\text{ V}$

Symbol	Parameter	Min.	Typ.	Max.	Unit	Test Conditions	Note
$V_{(BR)DSS}$	Drain-Source Breakdown Voltage	1000			V	$V_{GS} = 0\text{ V}, I_D = 100\ \mu\text{A}$	
$V_{GS(th)}$	Gate Threshold Voltage	1.8	2.1	3.5	V	$V_{DS} = V_{GS}, I_D = 3\ \text{mA}$	Fig. 11
			1.6		V	$V_{DS} = V_{GS}, I_D = 3\ \text{mA}, T_J = 150^\circ\text{C}$	
$I_{DSS}$	Zero Gate Voltage Drain Current		1	100	$\mu\text{A}$	$V_{DS} = 1000\ \text{V}, V_{GS} = 0\ \text{V}$	
$I_{GSS}$	Gate-Source Leakage Current		10	250	nA	$V_{GS} = 15\ \text{V}, V_{DS} = 0\ \text{V}$	
$R_{DS(on)}$	Drain-Source On-State Resistance		120	155	m $\Omega$	$V_{GS} = 15\ \text{V}, I_D = 15\ \text{A}$	Fig. 4, 5, 6
			170			$V_{GS} = 15\ \text{V}, I_D = 15\ \text{A}, T_J = 150^\circ\text{C}$	
$g_{fs}$	Transconductance		7.7		S	$V_{DS} = 20\ \text{V}, I_{DS} = 15\ \text{A}$	Fig. 7
			6.7			$V_{DS} = 20\ \text{V}, I_{DS} = 15\ \text{A}, T_J = 150^\circ\text{C}$	
$C_{iss}$	Input Capacitance		350		pF	$V_{GS} = 0\ \text{V}, V_{DS} = 600\ \text{V}$ $f = 1\ \text{MHz}$ $V_{AC} = 25\ \text{mV}$	Fig. 17, 18
$C_{oss}$	Output Capacitance		40				
$C_{rss}$	Reverse Transfer Capacitance		3				
$E_{oss}$	$C_{oss}$ Stored Energy		9		$\mu\text{J}$		Fig. 16
$E_{ON}$	Turn-On Switching Energy (Body Diode FWD)		140		$\mu\text{J}$	$V_{DS} = 700\ \text{V}, V_{GS} = -4\ \text{V}/15\ \text{V}, I_D = 15\ \text{A},$ $R_{G(ext)} = 2.5\ \Omega, L = 156\ \mu\text{H}, T_J = 150^\circ\text{C}$	Fig. 26
$E_{OFF}$	Turn Off Switching Energy (Body Diode FWD)		25				
$t_{d(on)}$	Turn-On Delay Time		7		ns	$V_{DD} = 700\ \text{V}, V_{GS} = -4\ \text{V}/15\ \text{V}$ $I_D = 15\ \text{A}, R_{G(ext)} = 2.5\ \Omega,$ Timing relative to $V_{DS}$ Inductive load	Fig. 27, 28
$t_r$	Rise Time		8				
$t_{d(off)}$	Turn-Off Delay Time		14				
$t_f$	Fall Time		8				
$R_{G(int)}$	Internal Gate Resistance		16		$\Omega$	$f = 1\ \text{MHz}, V_{AC} = 25\ \text{mV}$	
$Q_{gs}$	Gate to Source Charge		4.8		nC	$V_{DS} = 700\ \text{V}, V_{GS} = -4\ \text{V}/15\ \text{V}$ $I_D = 15\ \text{A}$ Per IEC60747-8-4 pg 21	Fig. 12
$Q_{gd}$	Gate to Drain Charge		10.0				
$Q_g$	Total Gate Charge		21.5				

**Reverse Diode Characteristics** ( $T_c = 25^\circ\text{C}$  unless otherwise specified)

Symbol	Parameter	Typ.	Max.	Unit	Test Conditions	Note
$V_{SD}$	Diode Forward Voltage	4.8		V	$V_{GS} = -4\ \text{V}, I_{SD} = 7.5\ \text{A}$	Fig. 8, 9, 10
		4.4		V	$V_{GS} = -4\ \text{V}, I_{SD} = 7.5\ \text{A}, T_J = 150^\circ\text{C}$	
$I_S$	Continuous Diode Forward Current		16.5	A	$V_{GS} = -4\ \text{V}$	Note 1
$I_{S,pulse}$	Diode pulse Current		50	A	$V_{GS} = -4\ \text{V}$ , pulse width $t_p$ limited by $T_{jmax}$	Note 1
$t_{rr}$	Reverse Recover time	16		ns	$V_{GS} = -4\ \text{V}, I_{SD} = 15\ \text{A}, V_R = 700\ \text{V}$ $\text{dif}/\text{dt} = 2400\ \text{A}/\mu\text{s}, T_J = 150^\circ\text{C}$	Note 1
$Q_{rr}$	Reverse Recovery Charge	154		nC		
$I_{rrm}$	Peak Reverse Recovery Current	15		A		

**Thermal Characteristics**

Symbol	Parameter	Max.	Unit	Test Conditions	Note
$R_{\theta JC}$	Thermal Resistance from Junction to Case	1.5	$^\circ\text{C}/\text{W}$		Fig. 21
$R_{\theta JA}$	Thermal Resistance From Junction to Ambient	40			

## Typical Performance

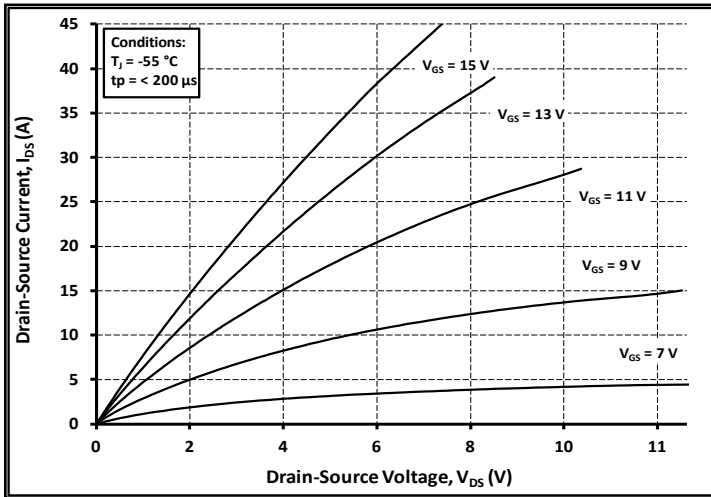

Figure 1. Output Characteristics  $T_J = -55\text{ }^\circ\text{C}$

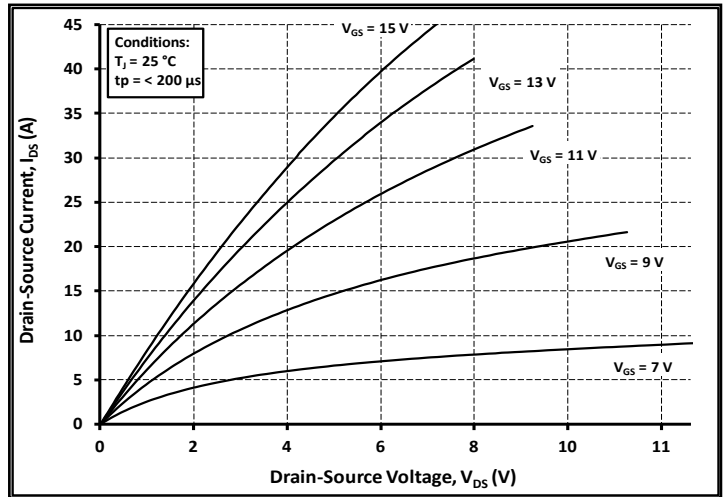

Figure 2. Output Characteristics  $T_J = 25\text{ }^\circ\text{C}$

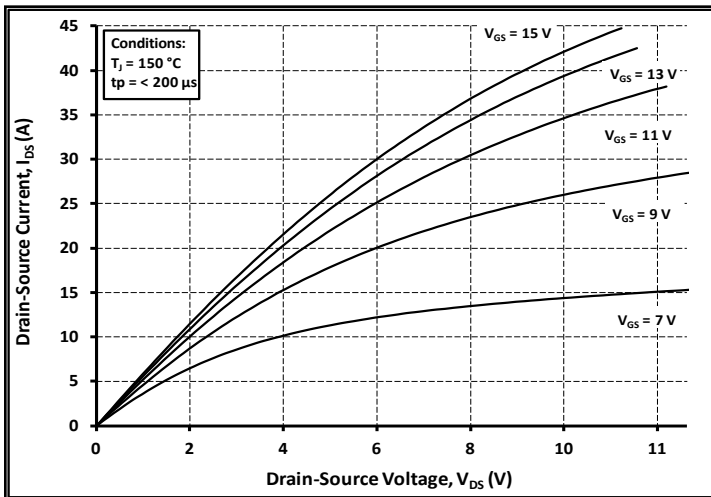

Figure 3. Output Characteristics  $T_J = 150\text{ }^\circ\text{C}$

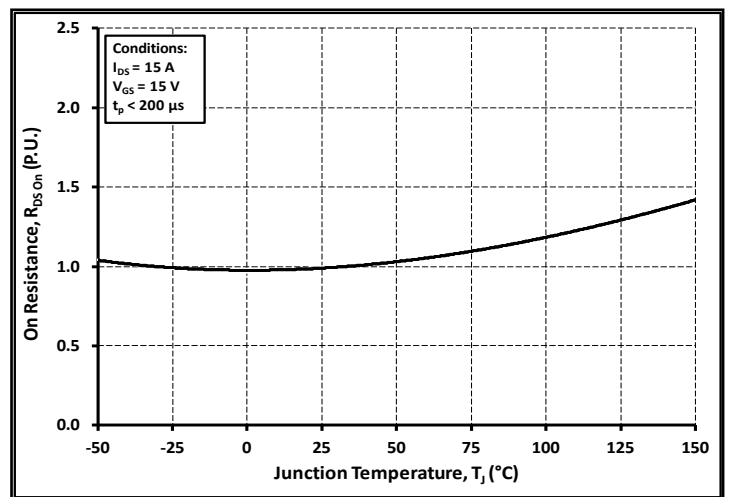

Figure 4. Normalized On-Resistance vs. Temperature

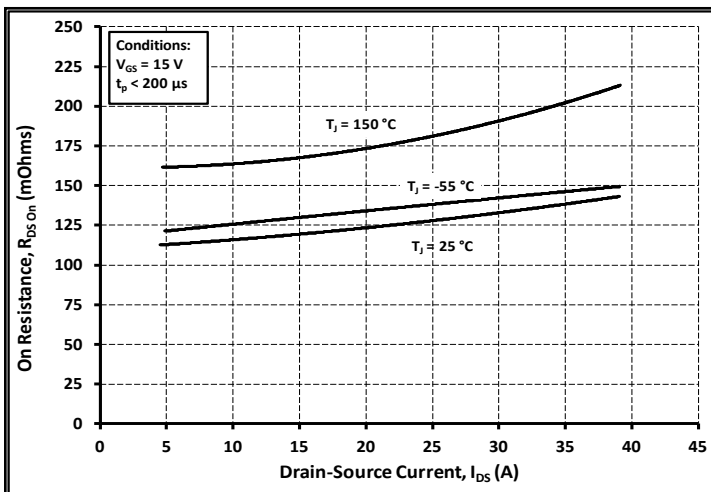

Figure 5. On-Resistance vs. Drain Current For Various Temperatures

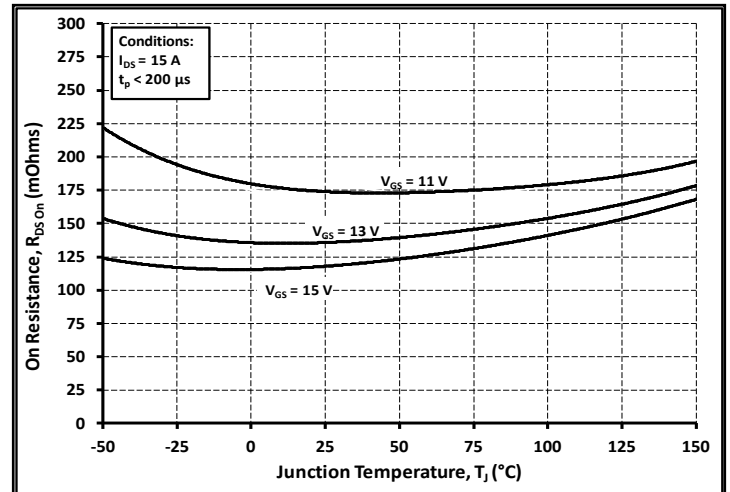

Figure 6. On-Resistance vs. Temperature For Various Gate Voltage

## Typical Performance

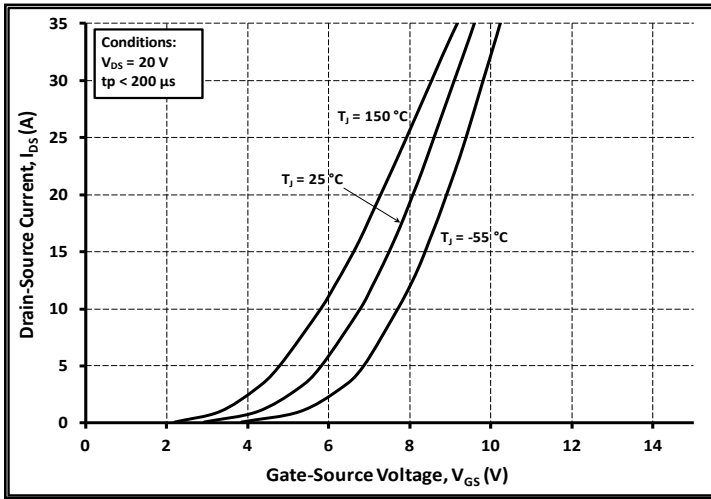

Figure 7. Transfer Characteristic for Various Junction Temperatures

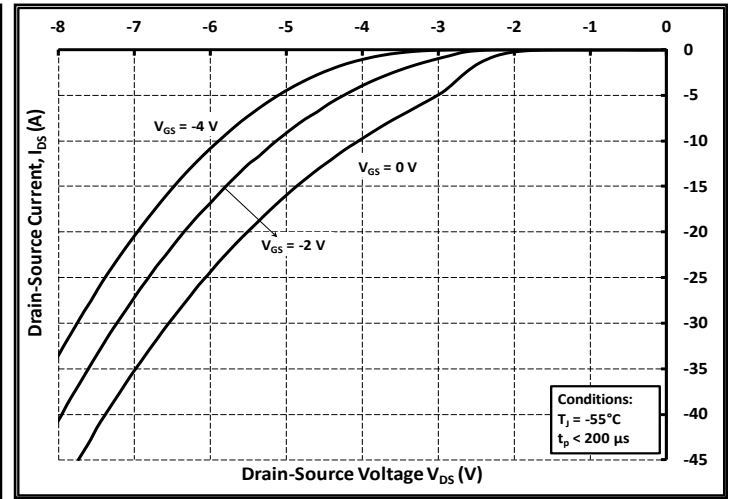

Figure 8. Body Diode Characteristic at  $-55\text{ }^\circ\text{C}$

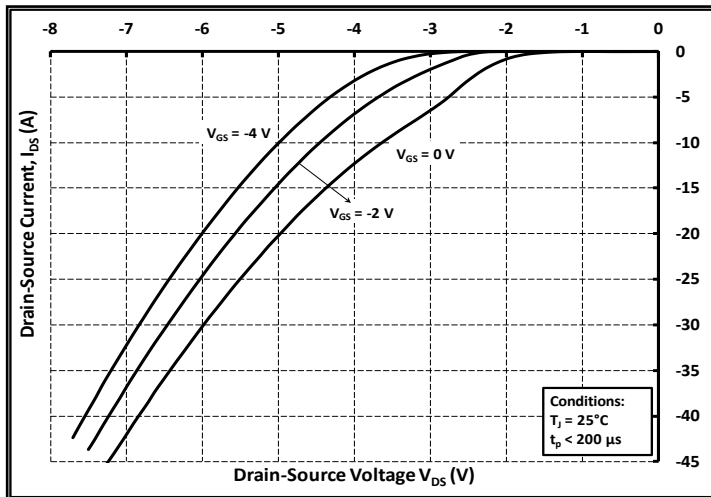

Figure 9. Body Diode Characteristic at  $25\text{ }^\circ\text{C}$

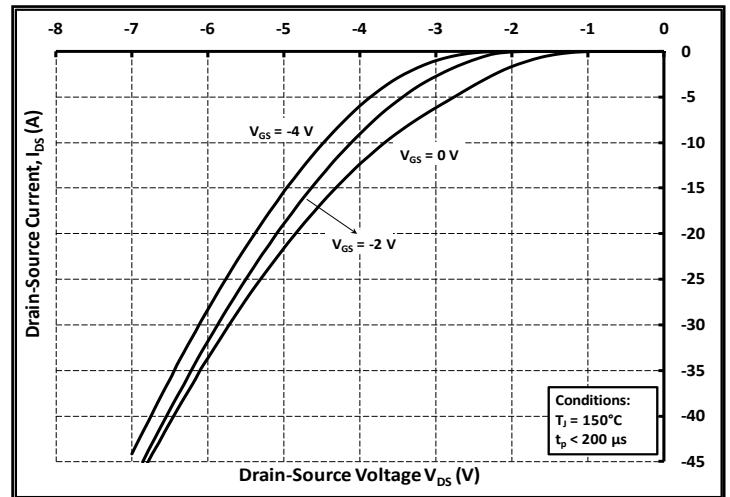

Figure 10. Body Diode Characteristic at  $150\text{ }^\circ\text{C}$

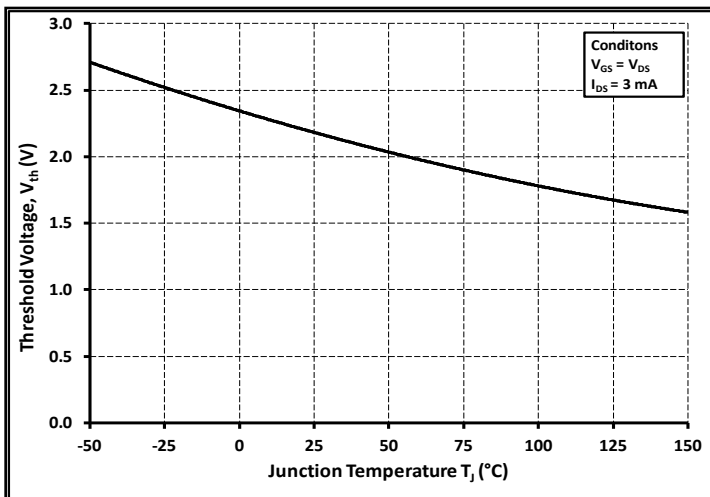

Figure 11. Threshold Voltage vs. Temperature

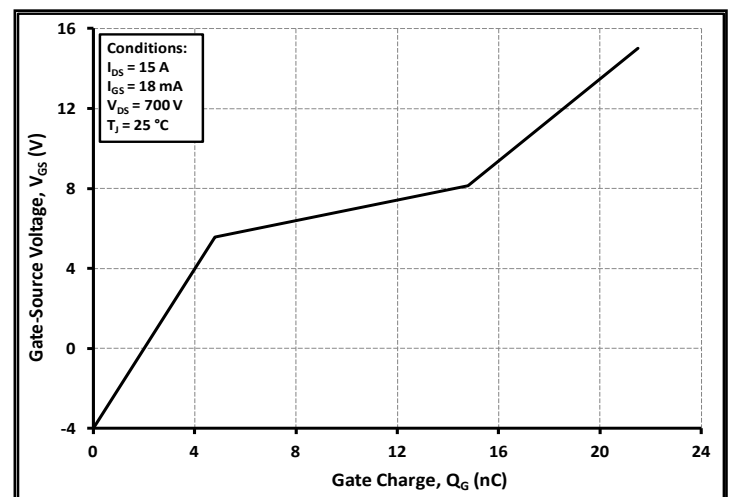

Figure 12. Gate Charge Characteristics

## Typical Performance

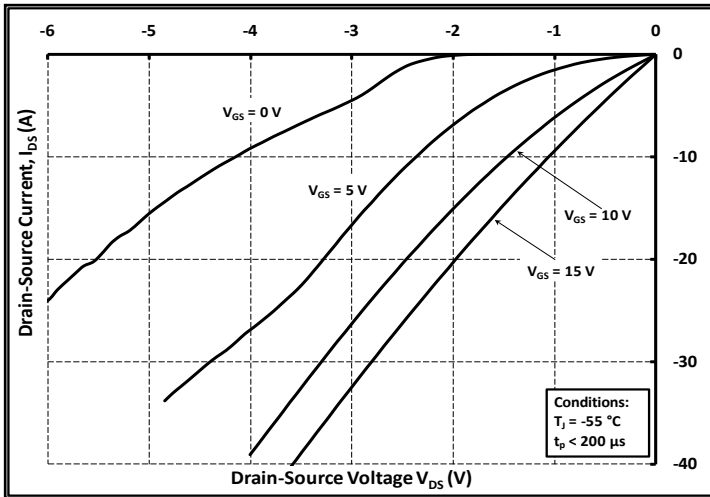

Figure 13. 3rd Quadrant Characteristic at -55 °C

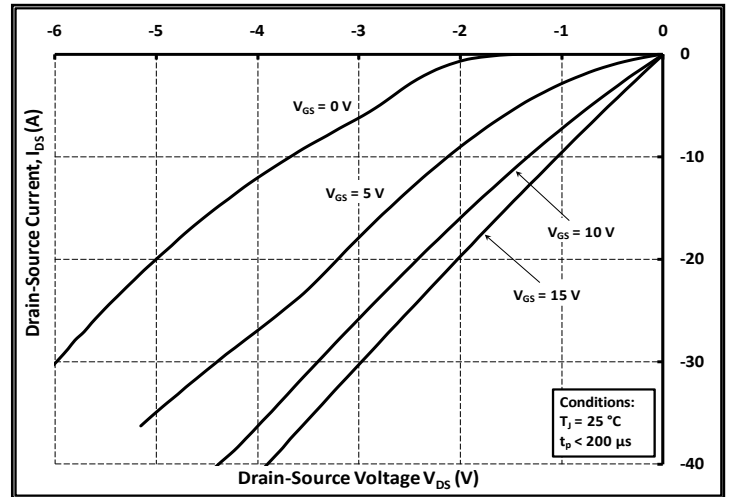

Figure 14. 3rd Quadrant Characteristic at 25 °C

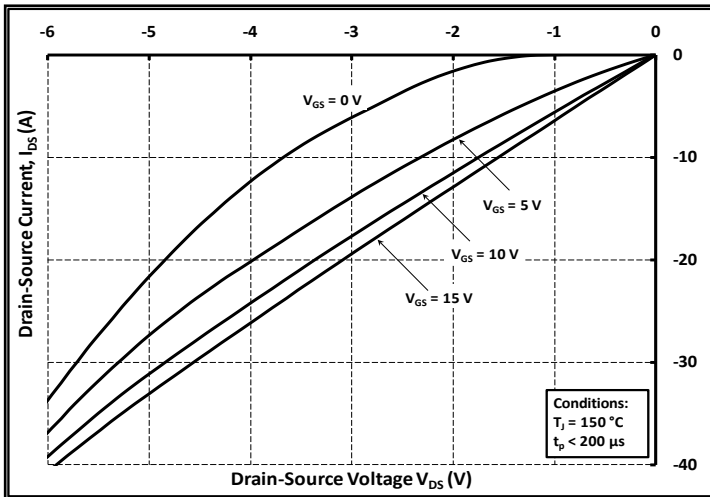

Figure 15. 3rd Quadrant Characteristic at 150 °C

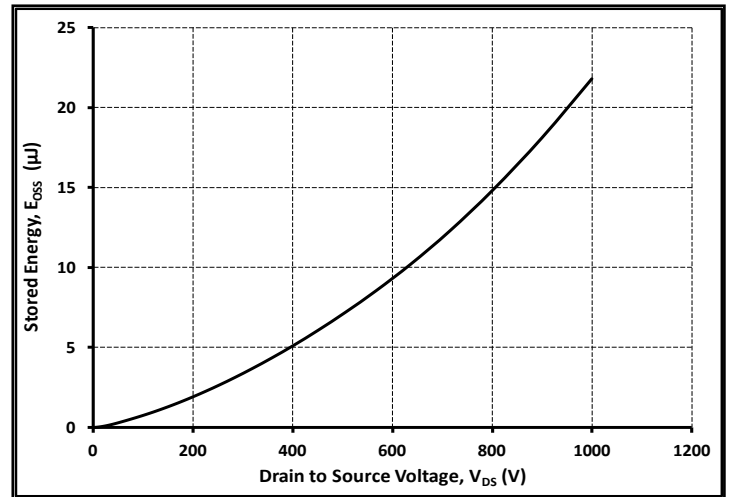

Figure 16. Output Capacitor Stored Energy

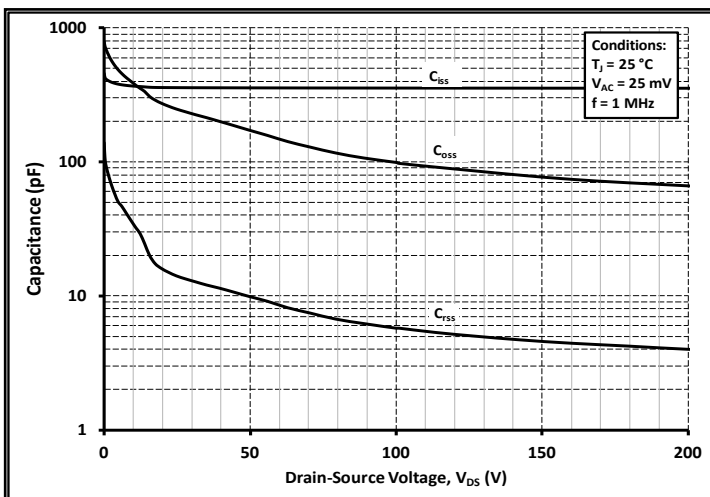

Figure 17. Capacitances vs. Drain-Source Voltage (0 - 200V)

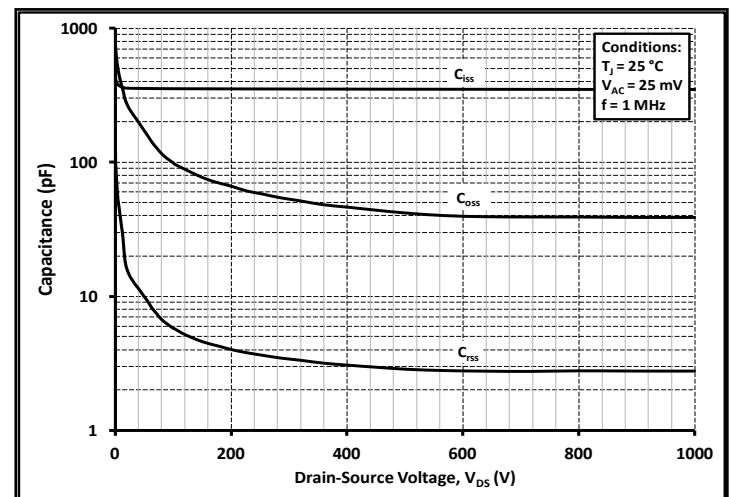

Figure 18. Capacitances vs. Drain-Source Voltage (0 - 1000V)

## Typical Performance

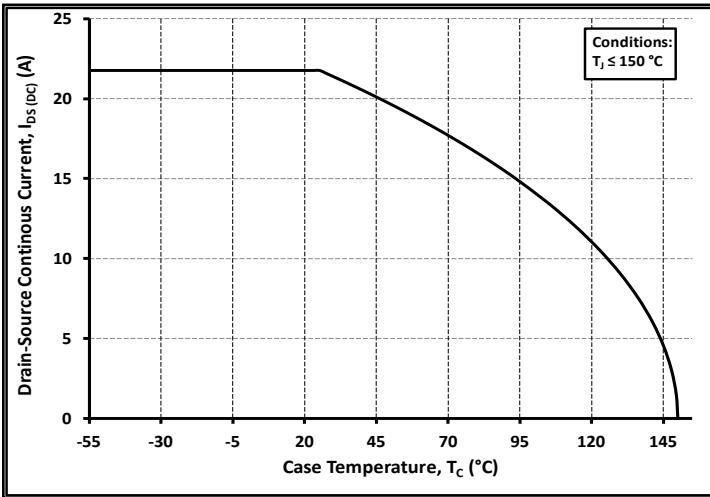

Figure 19. Continuous Drain Current Derating vs. Case Temperature

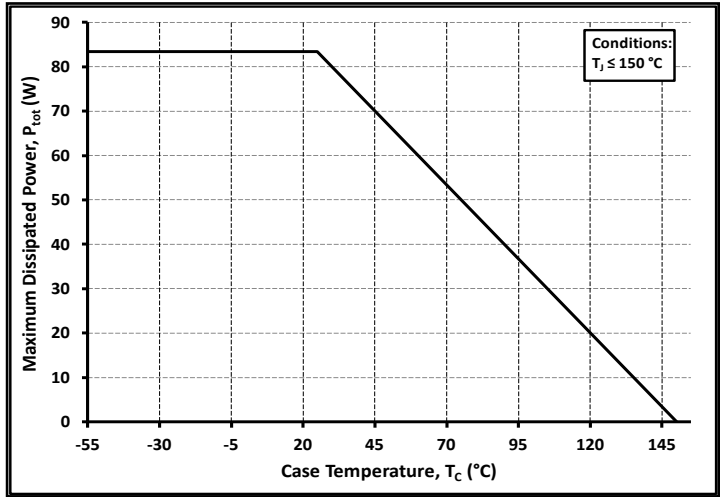

Figure 20. Maximum Power Dissipation Derating vs. Case Temperature

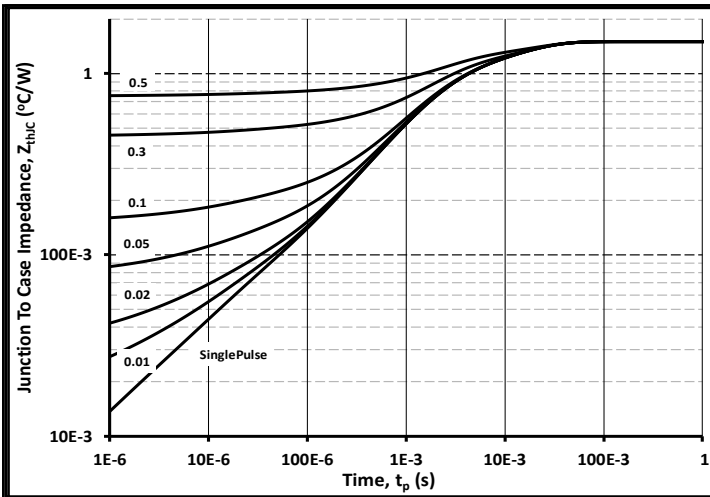

Figure 21. Transient Thermal Impedance (Junction - Case)

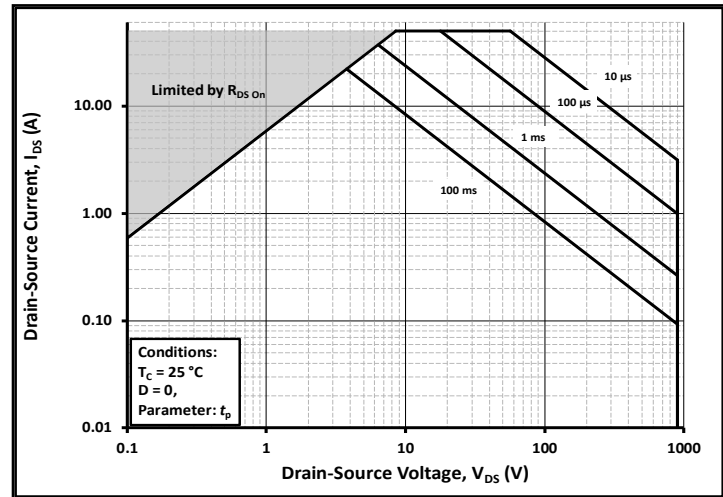

Figure 22. Safe Operating Area

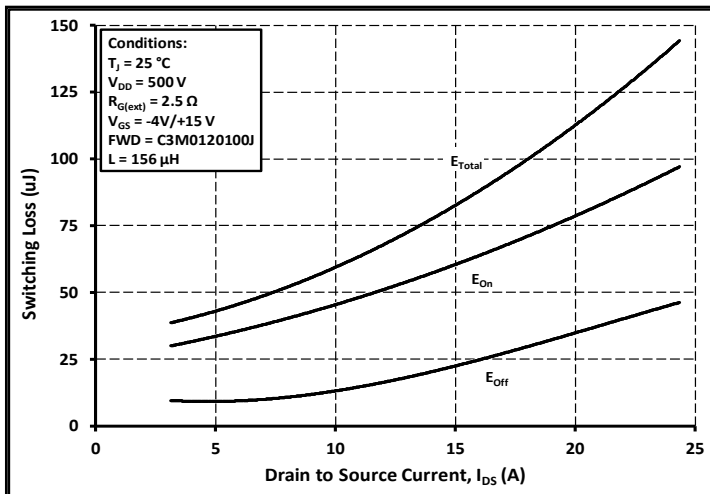

Figure 23. Clamped Inductive Switching Energy vs. Drain Current ( $V_{DD} = 500V$ )

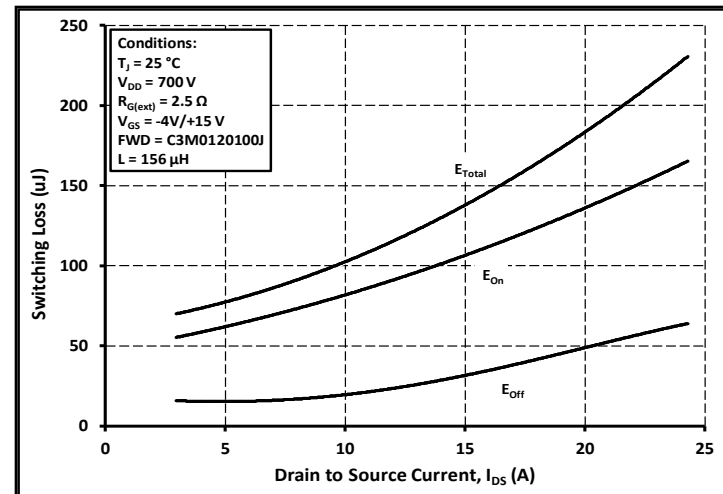

Figure 24. Clamped Inductive Switching Energy vs. Drain Current ( $V_{DD} = 700V$ )

## Typical Performance

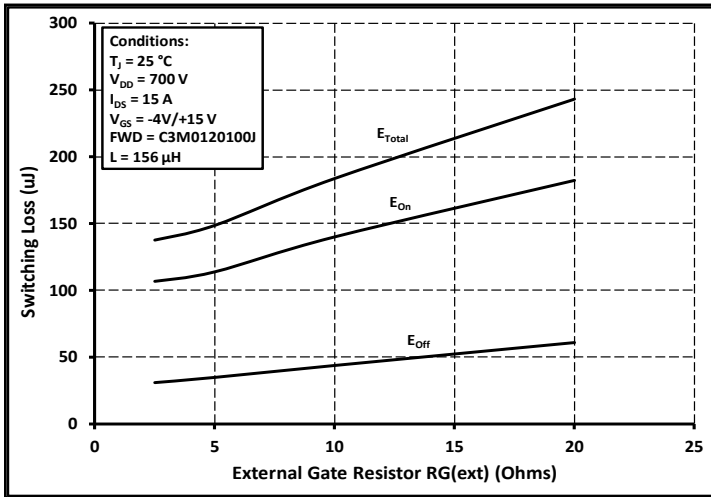

Figure 25. Clamped Inductive Switching Energy vs.  $R_{G(ext)}$

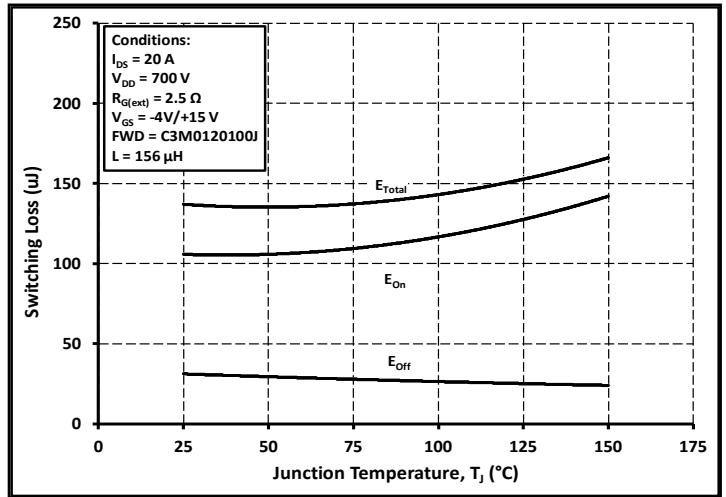

Figure 26. Clamped Inductive Switching Energy vs. Temperature

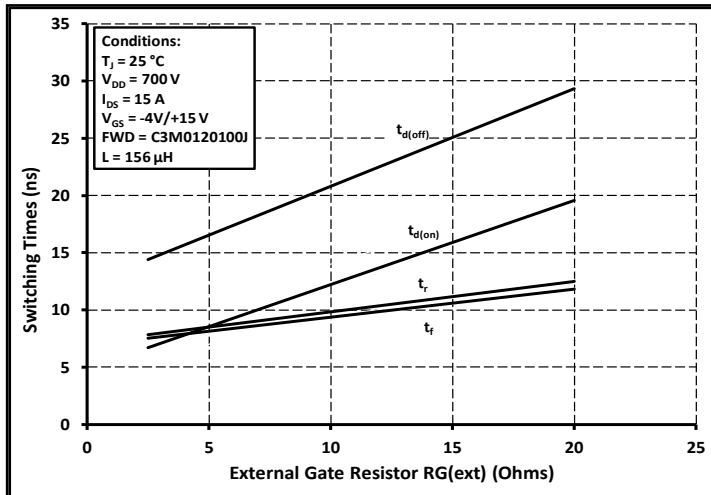

Figure 27. Switching Times vs.  $R_{G(ext)}$

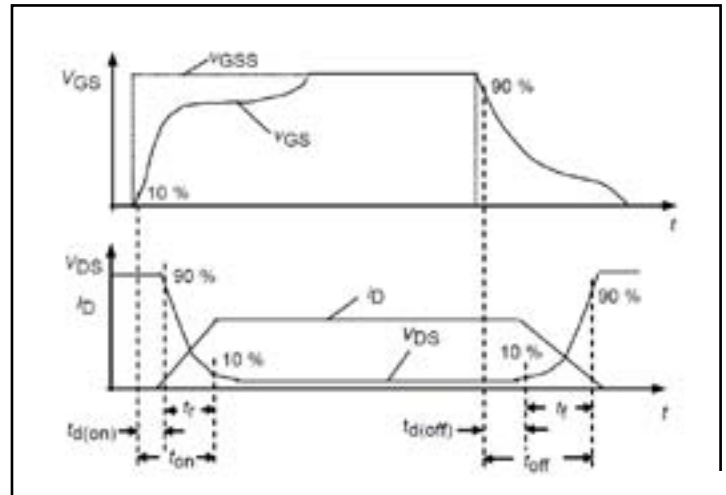

Figure 28. Switching Times Definition

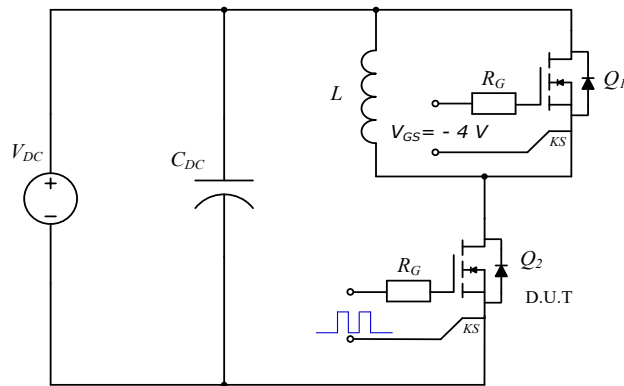

Figure 29. Clamped Inductive Switching Waveform Test Circuit

Note (3): Turn-off and Turn-on switching energy and timing values measured using SiC MOSFET Body Diode as shown above.



## Package Dimensions

### Package 7L D2PAK

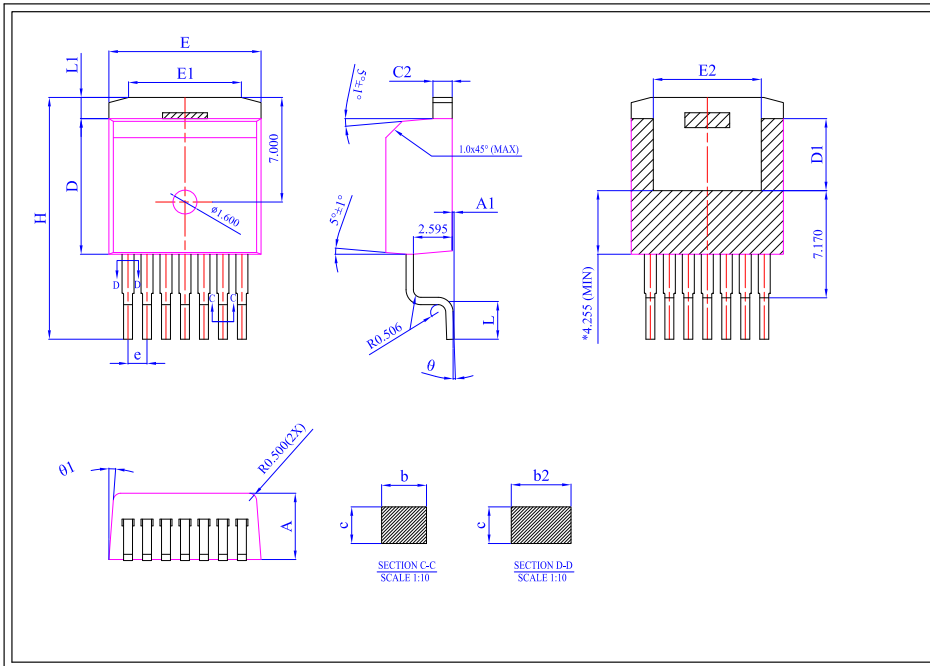

Dim	All Dimensions in Millimeters		
	Min	typ	Max
A	4.300	4.435	4.570
A1	0.00	0.125	0.25
b	0.500	0.600	0.700
b2	0.600	0.800	1.000
c	0.330	0.490	0.650
C2	1.170	1.285	1.400
D	9.025	9.075	9.125
D1	4.700	4.800	4.900
E	10.130	10.180	10.230
E1	6.500	7.550	8.600
E2	6.778	7.223	7.665
e	1.27		
H	15.043	16.178	17.313
L	2.324	2.512	2.700
L1	0.968	1.418	1.868
Ø	0°	4°	8°
Ø1	4.5°	5°	5.5°

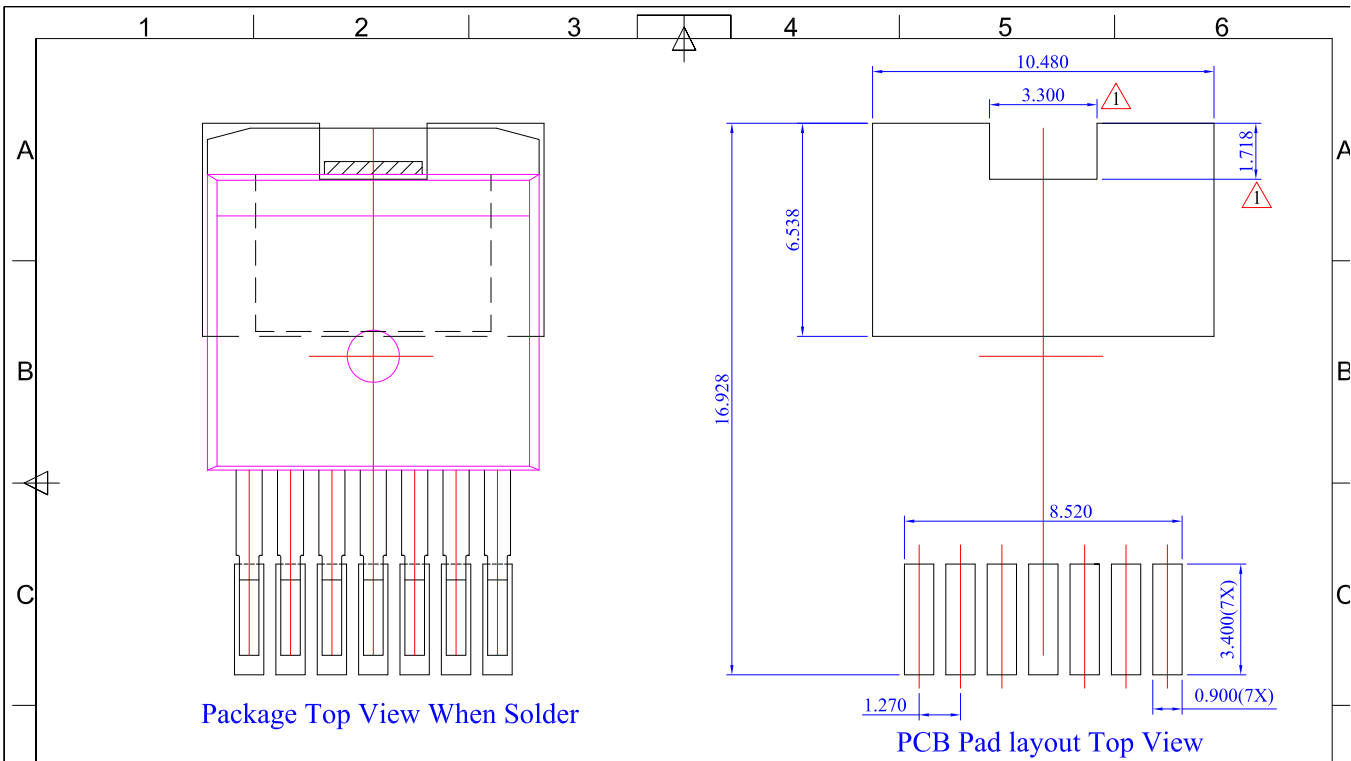

NOTES:  
1. ALL DIMENSION ARE IN MILLIMETERS. ANGLES ARE IN DEGREES.

REV	DATA	DESCRIPTION
2	2016-08-01	Change the package name from "D2PAK-7L" to "TO-263-7L".
1	2016-07-25	Modify pad layout.
0	2015-03-31	New case drawing.

PROJECTION	DRAWING NO.	REV.	SCALE	SHEET
	CPL0209	2	NTS	1/1
Tolerance unless specified ±0.050mm				

DATE	2016-08-01
DATE	2016-08-01
DATE	2016-08-01

## Notes

---

- **RoHS Compliance**  
The levels of RoHS restricted materials in this product are below the maximum concentration values (also referred to as the threshold limits) permitted for such substances, or are used in an exempted application, in accordance with EU Directive 2011/65/EC (RoHS2), as implemented January 2, 2013. RoHS Declarations for this product can be obtained from your Cree representative or from the Product Documentation sections of [www.cree.com](http://www.cree.com).
- **REACH Compliance**  
REACH substances of high concern (SVHCs) information is available for this product. Since the European Chemical Agency (ECHA) has published notice of their intent to frequently revise the SVHC listing for the foreseeable future, please contact a Cree representative to insure you get the most up-to-date REACH SVHC Declaration. REACH banned substance information (REACH Article 67) is also available upon request.
- This product has not been designed or tested for use in, and is not intended for use in, applications implanted into the human body nor in applications in which failure of the product could lead to death, personal injury or property damage, including but not limited to equipment used in the operation of nuclear facilities, life-support machines, cardiac defibrillators or similar emergency medical equipment, aircraft navigation or communication or control systems, air traffic control systems.

## Related Links

---

- **SPICE Models:** <http://wolfspeed.com/power/tools-and-support>
- **SiC MOSFET Isolated Gate Driver reference design:** <http://wolfspeed.com/power/tools-and-support>
- **SiC MOSFET Evaluation Board:** <http://wolfspeed.com/power/tools-and-support>