

CAS325M12HM2

1.2 kV, 3.7 mΩ All-Silicon Carbide High-Performance, Half-Bridge Module C2M MOSFET and Z-Rec™ Diode

V_{DS}	1.2 kV
$E_{sw, Total @ 600 V, 300 A}$	9.3 mJ
$R_{DS(on)}$	3.7 mΩ

Features

- Ultra-Low Loss, Low (5 nH) Inductance
- Ultra-Fast Switching Operation
- Zero Reverse Recovery Current from Diode
- Zero Turn-Off Tail Current from MOSFET
- Normally-Off, Fail-Safe Device Operation
- AlSiC Baseplate and Si₃N₄ AMB Substrate
- Ease of Paralleling
- High-Temperature Packaging, $T_{J(max)} = 175\text{ °C}$
- AS9100 / ISO9001 Certified Manufacturing

System Benefits

- Enables Compact and Lightweight Systems
- High-Efficiency Operation
- Reduced Thermal Requirements

Applications

- High-Efficiency Converters / Inverters
- Motor & Traction Drives
- Smart-Grid / Grid-Tied Distributed Generation

Package 65 mm x 110 mm x 10 mm



Part Number	Package	Marking
CAS325M12HM2	Half-Bridge Module	CAS325M12HM2

Maximum Ratings ($T_c = 25\text{ °C}$ unless otherwise specified)

Symbol	Parameter	Value	Unit	Test Conditions	Notes
V_{DSmax}	Drain - Source Voltage	1.2	kV		
V_{GSmax}	Gate - Source Voltage, Maximum Values	-10/+25	V	$T_J = -55\text{ to }150\text{ °C}$	
		-10/+23		$T_J = -55\text{ to }175\text{ °C}$	
V_{GSop}	Gate - Source Voltage, Recommended Operational Values	-5/+20	V	$T_J = -55\text{ to }150\text{ °C}$	
		-5/+18		$T_J = -55\text{ to }175\text{ °C}$	
I_D	Continuous Drain Current	444	A	$T_c = 25\text{ °C}, T_J = 175\text{ °C}$	Fig. 21
		256		$T_c = 125\text{ °C}, T_J = 175\text{ °C}$	
T_{Jmax}	Maximum Junction Temperature	175	°C		
T_c, T_{STG}	Case and Storage Temperature Range	-55 to +175	°C		
V_{isol}	Case Isolation Voltage	1.2	kV	AC, 50 Hz, 1 min	
L_{stray}	Stray Inductance	5	nH	Measured between terminals 1 and 3	
P_D	Power Dissipation	1500	W	$T_c = 25\text{ °C}, T_J = 175\text{ °C}$ (per switch)	Fig. 20

Electrical Characteristics ($T_c = 25\text{ }^\circ\text{C}$ unless otherwise specified)

Symbol	Parameter	Min.	Typ.	Max.	Unit	Test Conditions	Note
V_{DSS}	Drain - Source Blocking Voltage	1.2			kV	$V_{GS} = -5\text{ V}, I_D = 3.7\text{ mA}$	
$V_{GS(th)}$	Gate Threshold Voltage	2.0	2.6	4	V	$V_{DS} = V_{GS}, I_D = 105\text{ mA}$	
			2.0			$V_{DS} = V_{GS}, I_D = 105\text{ mA}, T_J = 175\text{ }^\circ\text{C}$	
I_{DSS}	Zero Gate Voltage Drain Current		614	3700	μA	$V_{DS} = 1.2\text{ kV}, V_{GS} = 0\text{ V}$	
I_{GSS}	Gate-Source Leakage Current			4.2		$V_{GS} = 20\text{ V}, V_{DS} = 0\text{ V}$	
$R_{DS(on)}$	On-State Resistance		3.7	5.0	m Ω	$V_{GS} = 20\text{ V}, I_{DS} = 350\text{ A}$	Fig. 5, 6, 7
			7.5			$V_{GS} = 18\text{ V}, I_{DS} = 350\text{ A}, T_J = 175\text{ }^\circ\text{C}$	
C_{ISS}	Input Capacitance		19.5		nF	$V_{GS} = 0\text{ V}, V_{DS} = 1000\text{ V}, f = 1\text{ MHz}, V_{AC} = 25\text{ mV}$	Fig. 14, 15
C_{OSS}	Output Capacitance		1.54				
C_{RSS}	Reverse Transfer Capacitance		0.10				
E_{on}	Turn-On Switching Energy		5.6		mJ	$V_{DD} = 600\text{ V}, V_{GS} = -5\text{ V}/+20\text{ V}$ $I_D = 300\text{ A}, R_{G(ext)} = 2\text{ }\Omega$ Note: IEC 60747-8-4 Definitions	Fig. 16
E_{off}	Turn-Off Switching Energy		3.7				
E_{Diode}	Diode Switching Energy		2.8				
Q_{GS}	Gate-Source Charge		322		nC	$V_{DD} = 800\text{ V}, V_{GS} = -5\text{ V}/+20\text{ V},$ $I_D = 350\text{ A},$ Per JEDEC24 pg 27	Fig. 13
Q_{GD}	Gate-Drain Charge		350				
Q_G	Total Gate Charge		1127				
$t_{D(on)}$	Turn-On Delay Time		47.6		ns	$V_{DD} = 600\text{ V}, V_{GS} = -5\text{ V}/+20\text{ V}$ $I_D = 300\text{ A}, R_{G(ext)} = 2\text{ }\Omega, L = 33\text{ }\mu\text{H}$ Note: IEC 60747-8-4, pg 83 Inductive Load	
t_R	Rise Time		35.2				
$t_{D(off)}$	Turn-Off Delay Time		114				
t_F	Fall Time		29.2				
V_{SD}	Diode Forward Voltage		1.6	1.8	V	$I_F = 300\text{ A}, V_{GS} = -5\text{ V}$	Fig. 8
			2.3			$I_F = 300\text{ A}, T_J = 175\text{ }^\circ\text{C}, V_{GS} = -5\text{ V}$	
Q_C	Total Capacitive Charge		4.3		μC	Includes Schottky & Body diodes	

Note: The Diode Switching Energy is purely capacitive.

Thermal Characteristics

Symbol	Parameter	Min.	Typ.	Max.	Unit	Test Conditions	Note
R_{thJCM}	Thermal Resistance Junction-to-Case for MOSFET	0.085	0.100	0.115	$^\circ\text{C}/\text{W}$		Fig. 22, 23
R_{thJCD}	Thermal Resistance Junction-to-Case for Diode	0.094	0.110	0.127			

Additional Module Data

Symbol	Parameter	Min.	Typ.	Max.	Unit	Test Condition
W	Weight		140		g	
M	Mounting Torque	0.9	1.1	1.3	Nm	Power Terminals, M4 Bolts
		3	4.5	5		Baseplate, M6 Bolts
CTI	Comparative Tracking Index		600			
	Clearance Distance		13.3		mm	Terminal to Terminal
			5.6			Terminal to Baseplate
			8			Gate-Source Pin to Baseplate
	Creepage Distance		16.9			Terminal to Terminal
			13.5			Terminal to Baseplate
			12.3			Gate-Source Pin to Baseplate

Typical Performance

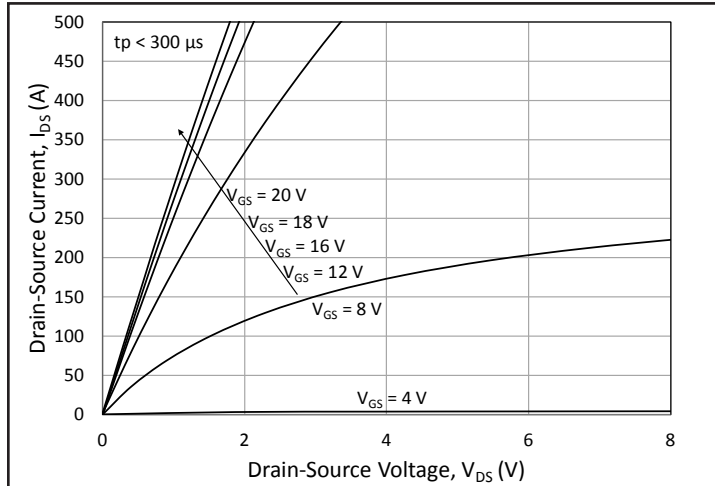

Figure 1. Typical Output Characteristics $T_J = 25\text{ }^\circ\text{C}$

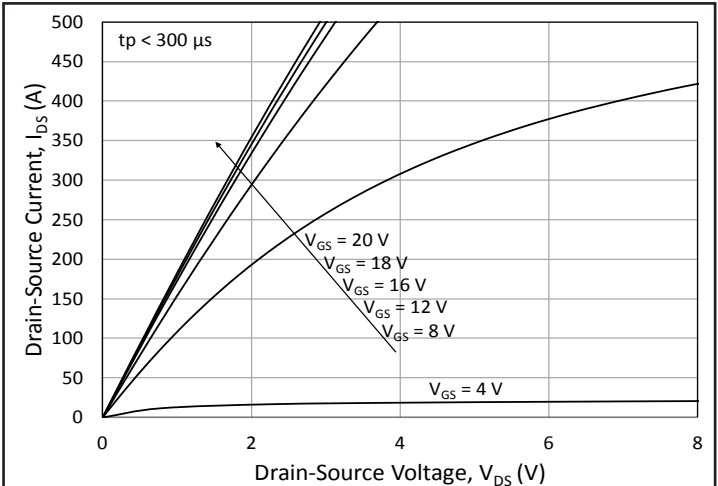

Figure 2. Typical Output Characteristics $T_J = 125\text{ }^\circ\text{C}$

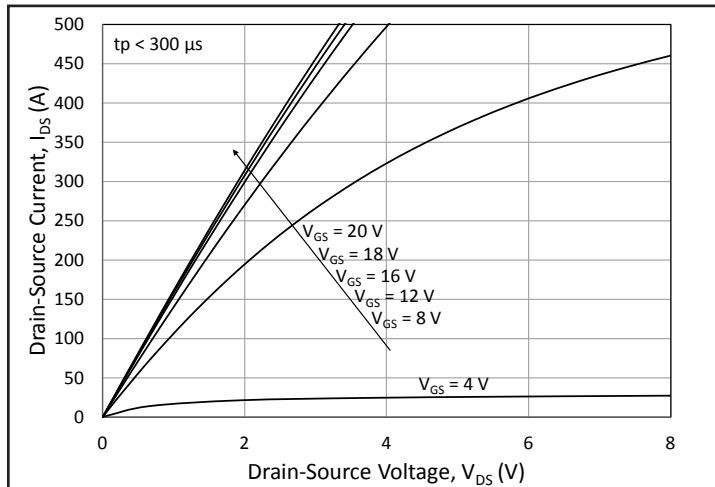

Figure 3. Typical Output Characteristics $T_J = 150\text{ }^\circ\text{C}$

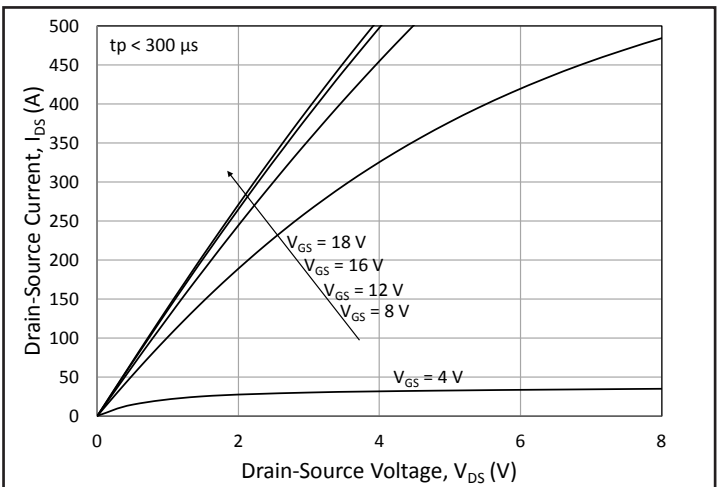

Figure 4. Typical Output Characteristics $T_J = 175\text{ }^\circ\text{C}$

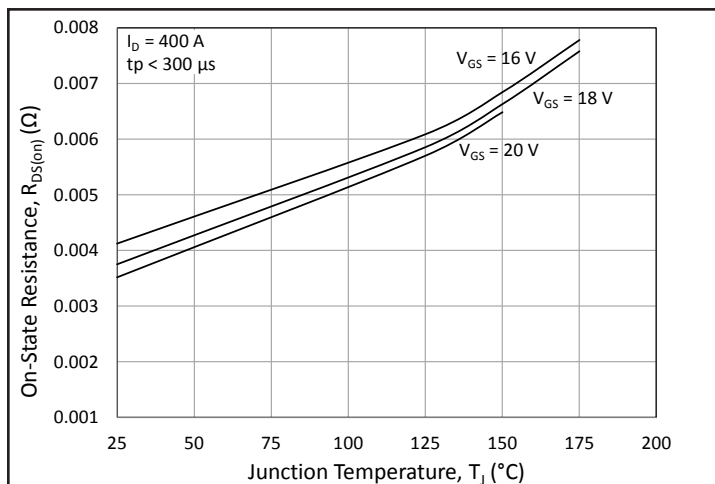

Figure 5. On-State Resistance vs. Temperature for Various Gate-Source Voltages

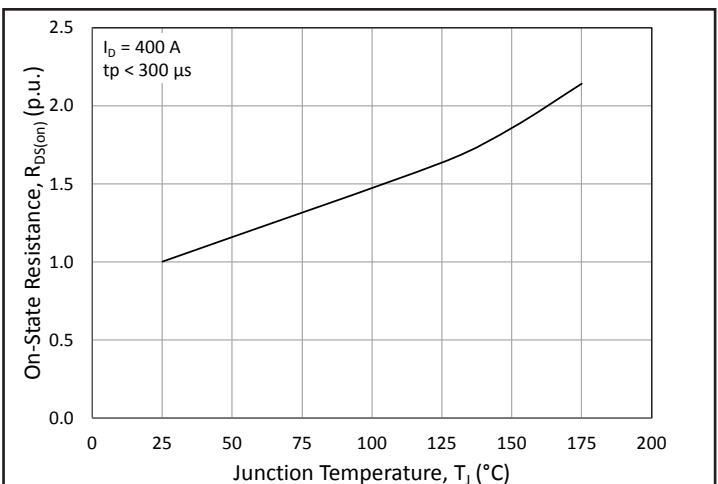

Figure 6. Normalized On-State Resistance vs. Temperature

Typical Performance

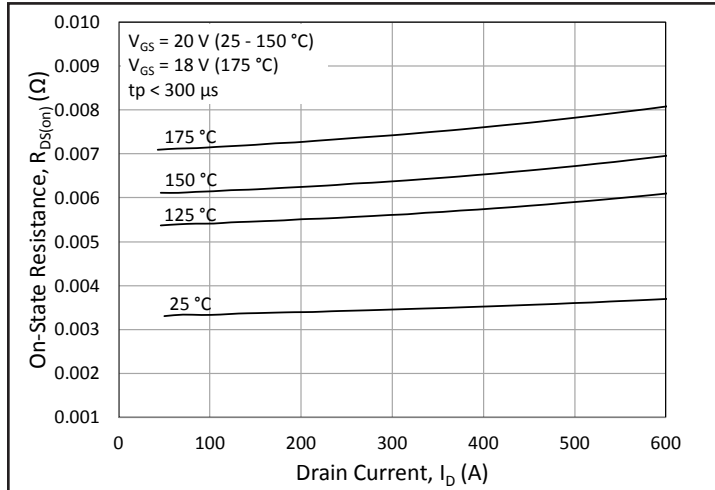

Figure 7. On-State Resistance vs. Drain Current for Various Temperatures

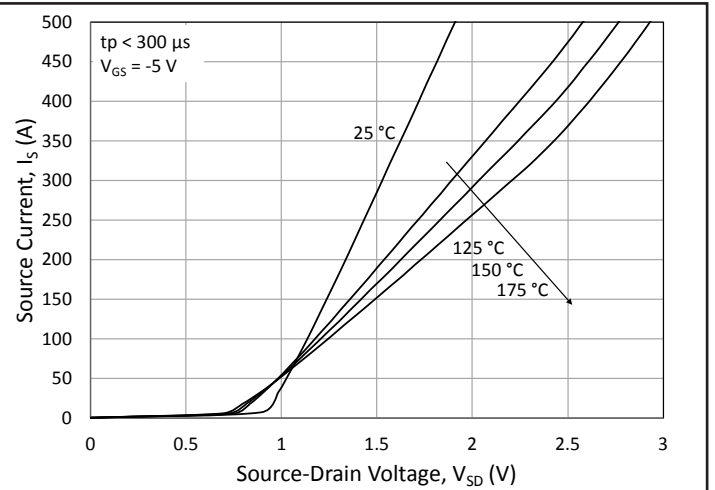

Figure 8. Antiparallel Diode Characteristic for Various Temperatures, $V_{GS} = -5 V$

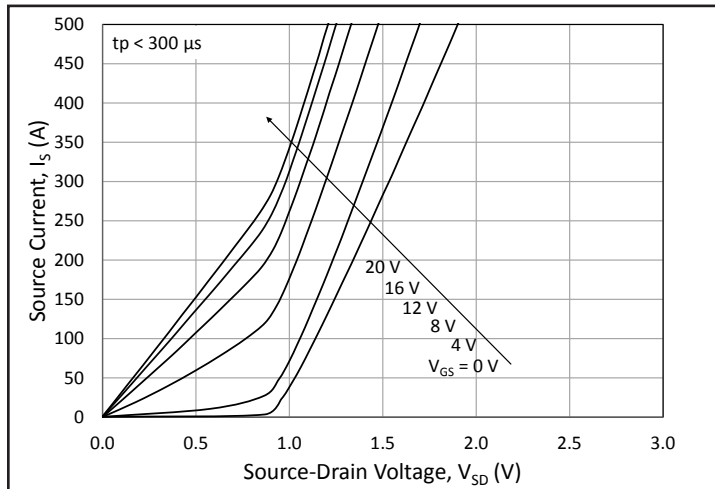

Figure 9. 3rd Quadrant Characteristic at 25 °C

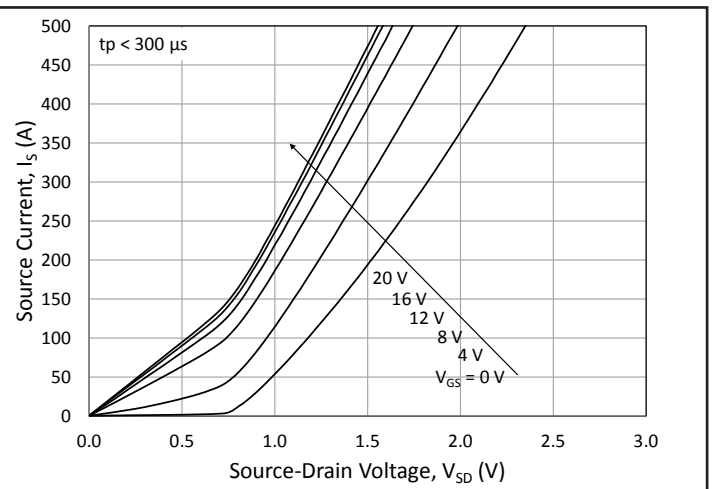

Figure 10. 3rd Quadrant Characteristic at 125 °C

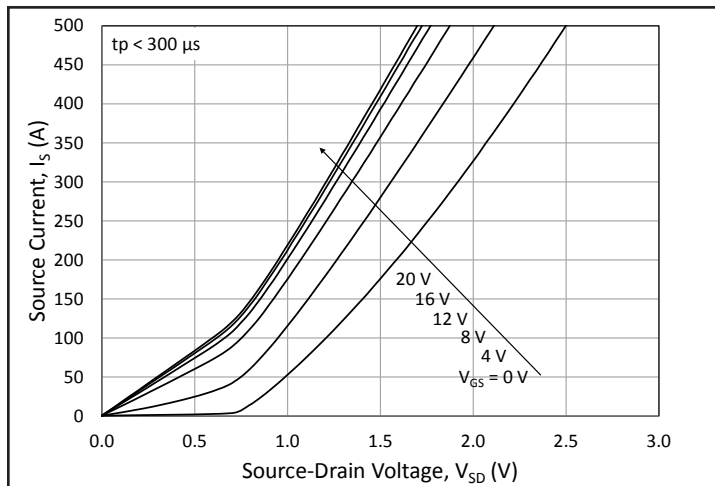

Figure 11. 3rd Quadrant Characteristic at 150 °C

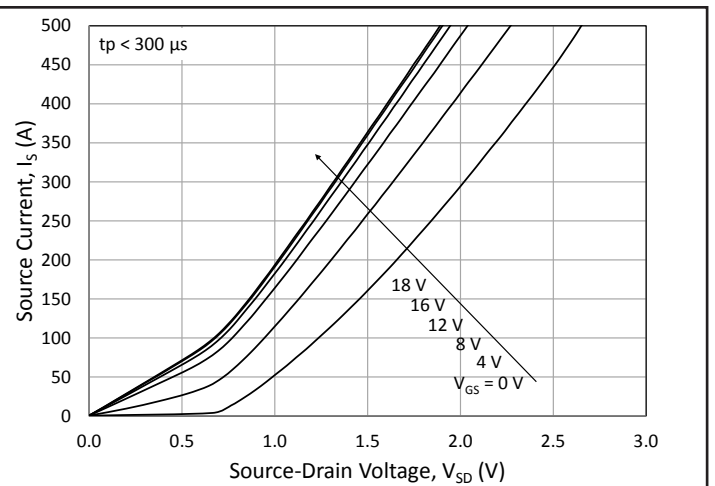

Figure 12. 3rd Quadrant Characteristic at 175 °C

Typical Performance

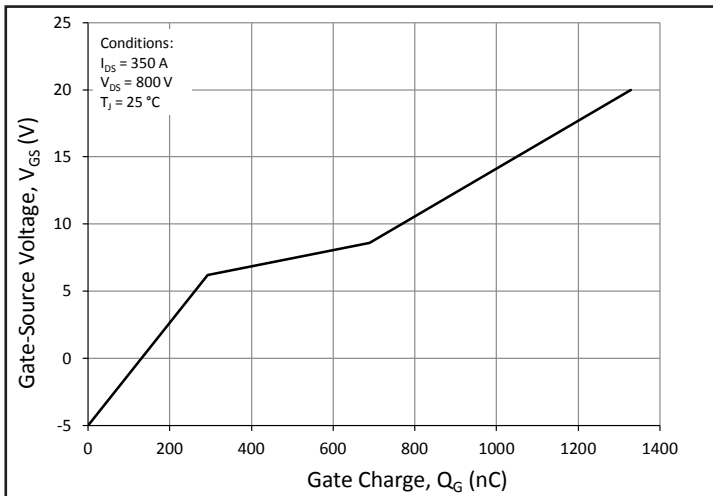

Figure 13. Scaled Gate Charge Characteristic

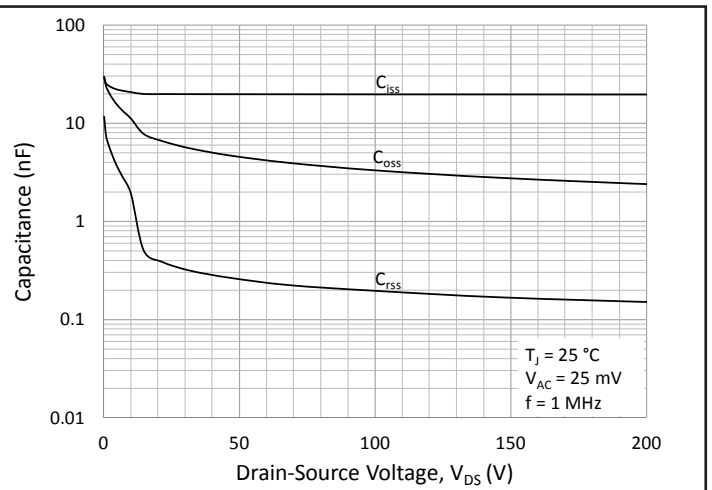

Figure 14. Typical Capacitances vs. Drain-Source Voltage (0 - 200 V)

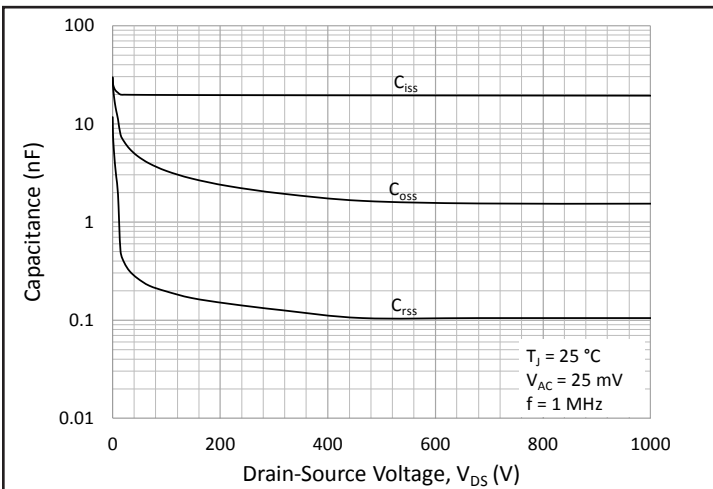

Figure 15. Typical Capacitances vs. Drain-Source Voltage (0 - 1 kV)

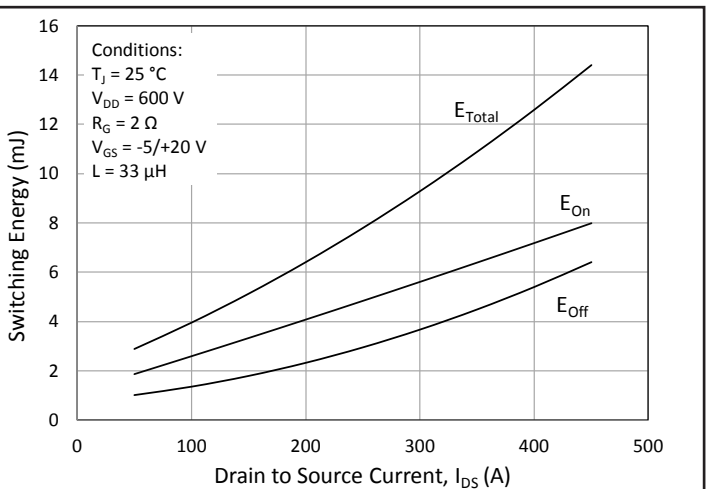

Figure 16. Inductive Switching Energy vs. Drain Current For $V_{DD} = 600 \text{ V}$, $R_G = 2 \text{ } \Omega$

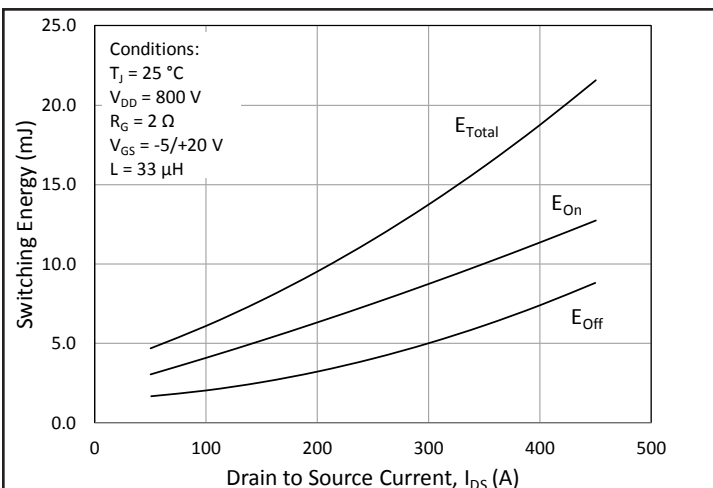

Figure 17. Inductive Switching Energy vs. Drain Current For $V_{DD} = 800 \text{ V}$, $R_G = 2 \text{ } \Omega$

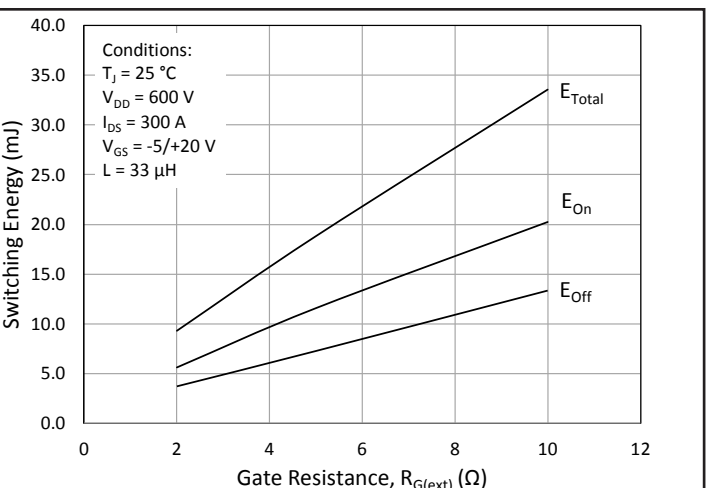

Figure 18. Inductive Switching Energy vs. External Gate Resistance, $I_{DS} = 300 \text{ A}$

Typical Performance

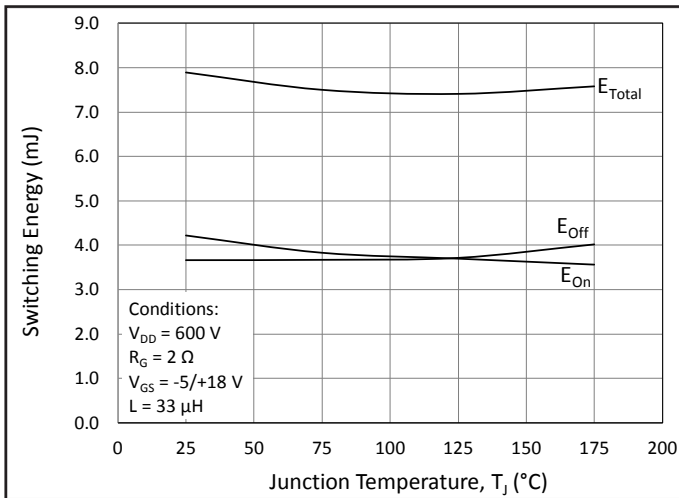

Figure 19. Inductive Switching Energy vs. Temperature

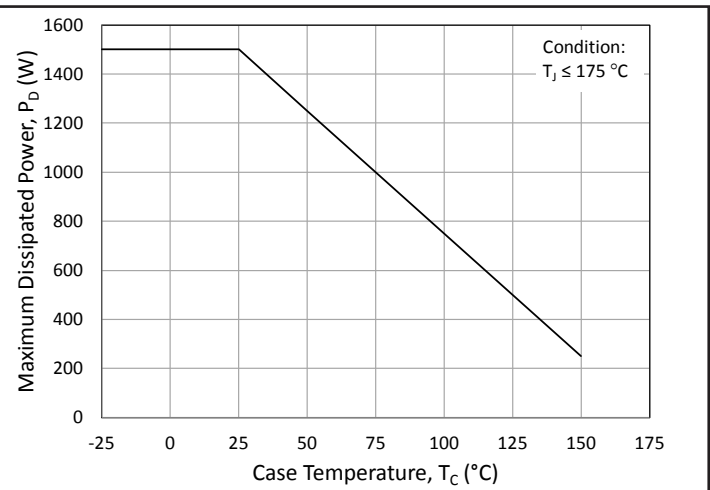

Figure 20. Maximum Power Dissipation (MOSFET) Derating Per Switch Position vs. Case Temperature

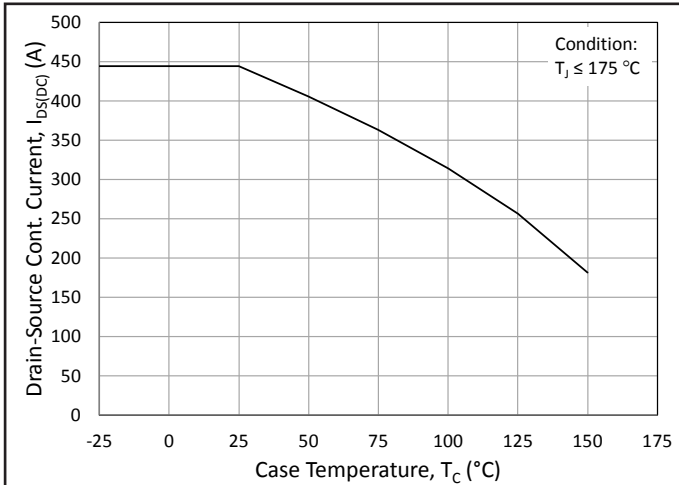

Figure 21. Continuous Drain Current Derating vs. Case Temperature

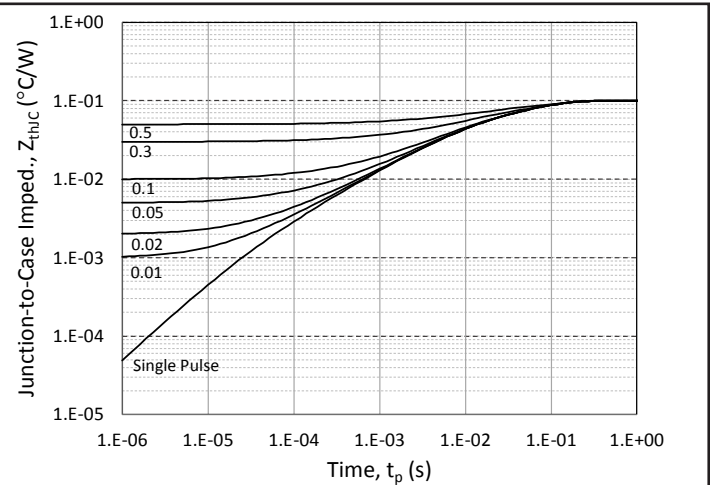

Figure 22. MOSFET Junction-to-Case Thermal Impedance

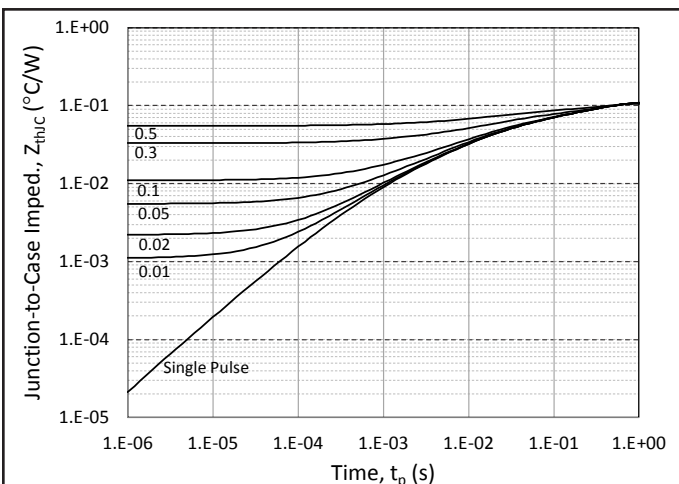

Figure 23. Schottky Diode Junction-to-Case Thermal Impedance

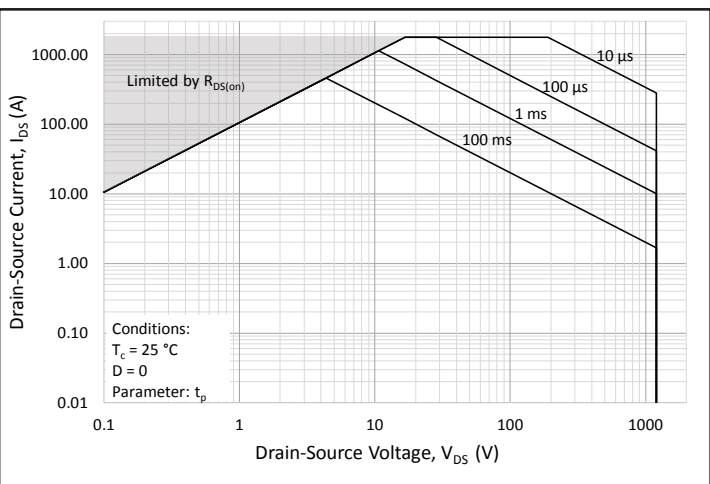
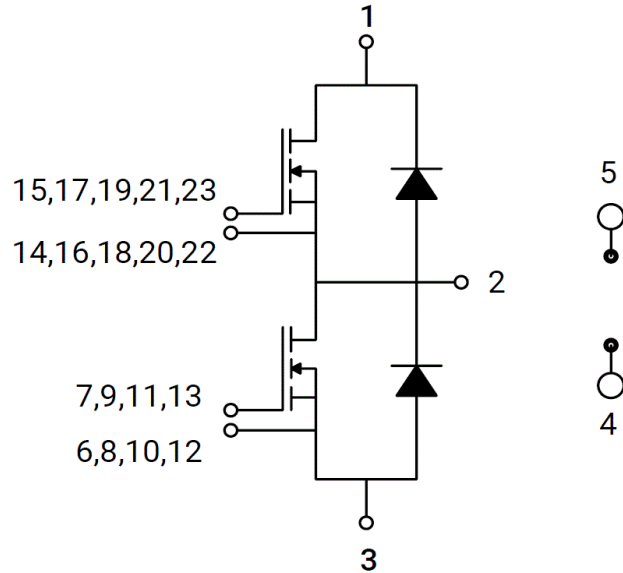
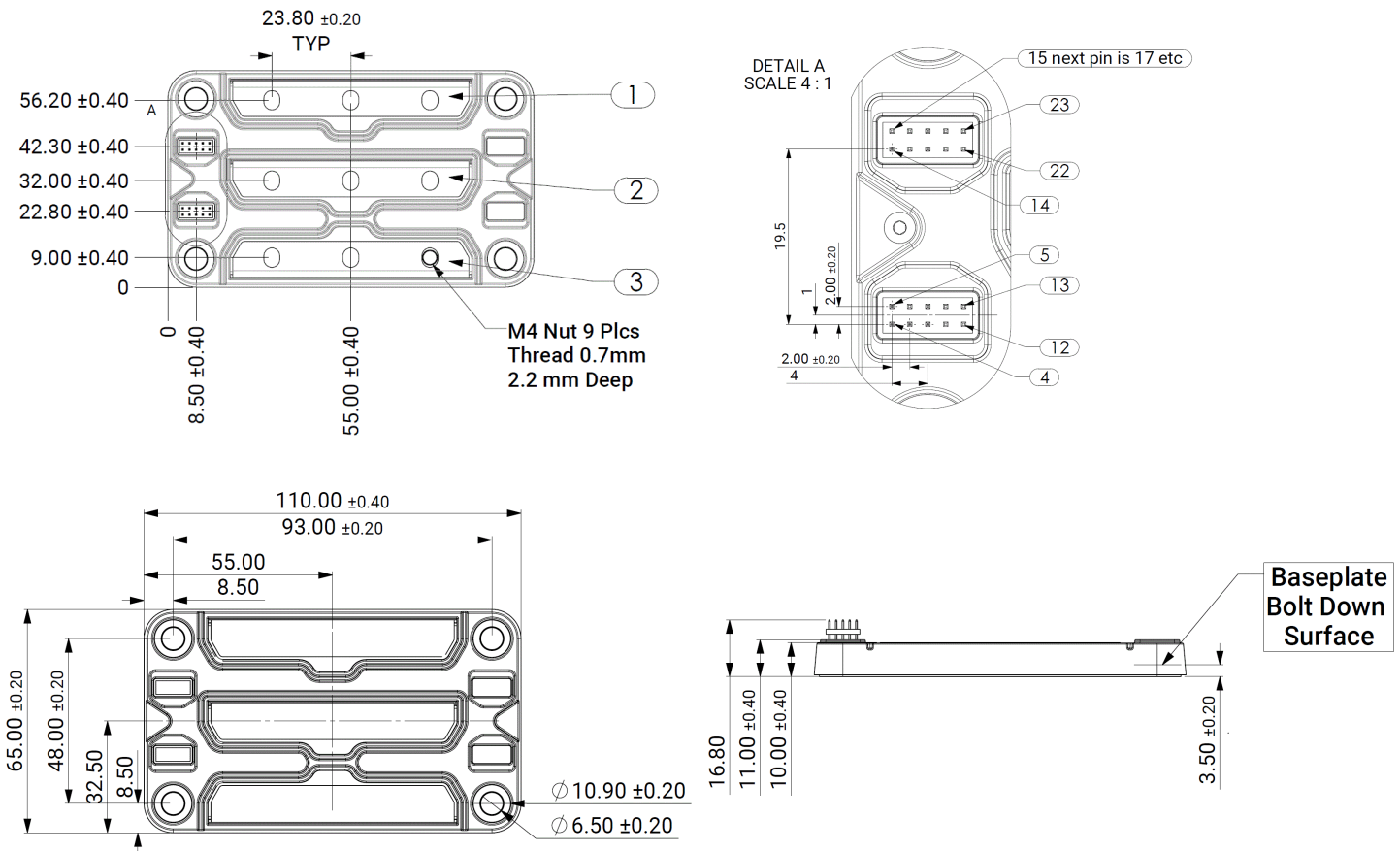

Figure 24. Safe Operating Area

Schematic



Package Dimensions (mm)



IF NO TOLERANCE IS SPECIFIED,
DIMENSION IS FOR REFERENCE ONLY.

(SURFACE MODEL AVAILABLE UPON
REQUEST)



Important Notes

- The SiC MOSFET module switches at speeds beyond what is customarily associated with IGBT-based modules. Therefore, special precautions are required to realize the best performance. The interconnection between the gate driver and module housing needs to be as short as possible. This will afford the best switching time and avoid the potential for device oscillation. Also, great care is required to ensure minimum inductance between the module and DC link capacitors to avoid excessive VDS overshoot.
- The module utilizes the ESQT-105-02-G-D-XXX family of elevated socket connectors from Samtec, which are available in varying heights according to the customer's preference.
- Companion Parts: CGD15HB62LP + CRD200DA12E High-Performance, Three-Phase Evaluation Unit.
- Some values were obtained from the CPM2-1200-0025B and CPW5-1200-Z050B device datasheets.
- This product has not been designed or tested for use in, and is not intended for use in, applications implanted into the human body nor in applications in which failure of the product could lead to death, personal injury or property damage, including but not limited to equipment used in the operation of nuclear facilities, life-support machines, cardiac defibrillators or similar emergency medical equipment, aircraft navigation or communication or control systems, air traffic control systems.
- The product described is not eligible for Distributor Stock Rotation or Inventory Price Protection.