

# CMPA5585030F

## 30 W, 5.5 - 8.5 GHz, GaN MMIC, Power Amplifier

Cree's CMPA5585030F is a gallium nitride (GaN) High Electron Mobility Transistor (HEMT) based monolithic microwave integrated circuit (MMIC). GaN has superior properties compared to silicon or gallium arsenide, including higher breakdown voltage, higher saturated electron drift velocity and higher thermal conductivity. GaN HEMTs also offer greater power density and wider bandwidths compared to Si and GaAs transistors. This MMIC is available in a 10 lead metal/ceramic flanged package for optimal electrical and thermal performance.

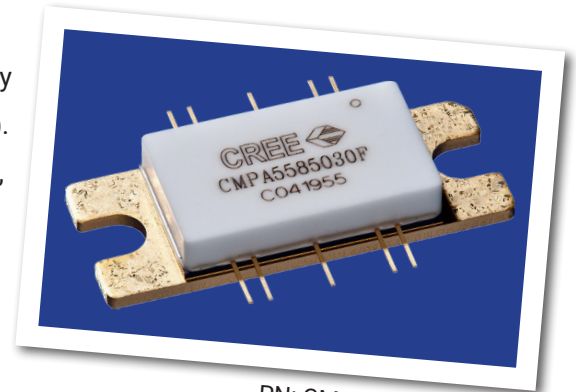

PN: CMPA5585030F  
Package Type: 440213

### Typical Performance Over 5.8-8.4 GHz ( $T_c = 25^\circ\text{C}$ )

Parameter	5.8 GHz	6.4 GHz	7.2 GHz	7.9 GHz	8.4 GHz	Units
S21 <sup>1,2</sup>	25.9	23.8	26.5	24.5	26.7	dB
Power Gain <sup>2,5</sup>	22.3	19.0	20.9	21.6	21.2	dB
PAE <sup>1,2,4,5</sup>	24.7	20.7	20.3	22.6	22.9	%
ACLR <sup>1,2,3,5</sup>	-37	-42	-33	-34	-40	dBc

Notes (unless otherwise specified):

1. At 25°C
2. Measurements are performed using Cree test fixture AD-938516
3. Under OQPSK modulated signal, 1.6 Msps, PN23, Alpha Filter = 0.2
4. Power Added Efficiency =  $(P_{OUT} - P_{IN}) / PDC$
5. Measured at  $P_{OUT} = 41\text{ dBm}$

### Features

- 25 dB Small Signal Gain
- 30 W Typical  $P_{SAT}$
- Operation up to 28 V
- High Breakdown Voltage
- High Temperature Operation
- Size 1.00 x 0.385 inches

### Applications

- Point to Point Radio
- Communications
- Satellite Communication Uplink

## Absolute Maximum Ratings (not simultaneous)

Parameter	Symbol	Rating	Units	Conditions
Drain-source Voltage	$V_{DSS}$	84	$V_{DC}$	25°C
Gate-source Voltage	$V_{GS}$	-10, +2	$V_{DC}$	25°C
Power Dissipation	$P_{DISS}$	55	W	
Storage Temperature	$T_{STG}$	-65, +150	°C	
Operating Junction Temperature	$T_J$	225	°C	
Maximum Forward Gate Current	$I_{GMAX}$	10	mA	25°C
Soldering Temperature <sup>1</sup>	$T_S$	245	°C	
Screw Torque	$\tau$	40	in-oz	
Thermal Resistance, Junction to Case	$R_{\theta JC}$	2.38	°C/W	CW, 85°C, $P_{DISS} = 43$ W
Case Operating Temperature	$T_C$	-40, +150	°C	

Note:

<sup>1</sup> Refer to the Application Note on soldering at [www.cree.com/RF/Document-Library](http://www.cree.com/RF/Document-Library)

## Electrical Characteristics (Frequency = 5.5 GHz to 8.5 GHz unless otherwise stated; $T_C = 25^\circ\text{C}$ )

Characteristics	Symbol	Min.	Typ.	Max.	Units	Conditions
<b>DC Characteristics<sup>1</sup></b>						
Gate Threshold Voltage	$V_{TH}$	-3.8	-2.8	-2.3	V	$V_{DS} = 10$ V, $I_{DS} = 20.6$ mA
Saturated Drain Current	$I_{DS}$	16.4	18.6	-	A	$V_{DS} = 6.0$ V, $V_{GS} = 2.0$ V
Drain-Source Breakdown Voltage	$V_{BD}$	84	100	-	V	$V_{GS} = -8$ V, $I_{DS} = 20.6$ mA
<b>RF Characteristics<sup>3</sup></b>						
Small Signal Gain	S21	22.85	26	-	dB	$V_{DD} = 28$ V, $I_{DQ} = 285$ mA, $P_{IN} = -20$ dBm
Input Return Loss	S11	-	-7	-	dB	$V_{DD} = 28$ V, $I_{DQ} = 285$ mA, $P_{IN} = -20$ dBm
Output Return Loss	S22	-	-7	-	dB	$V_{DD} = 28$ V, $I_{DQ} = 285$ mA, $P_{IN} = -20$ dBm
Output Mismatch Stress	VSWR	-	-	5:1	$\Psi$	No damage at all phase angles, $V_{DD} = 28$ V, $I_{DQ} = 285$ mA, $P_{OUT} = 43$ dBm

Notes:

<sup>1</sup> Measured on-wafer prior to packaging.

<sup>2</sup> Scaled from PCM data.

<sup>3</sup> Measured in the CMPA5585030F-AMP

## Electrical Characteristics Continued... (T<sub>c</sub> = 25°C)

Characteristics	Symbol	Min.	Typ.	Max.	Units	Conditions
<b>RF Characteristics<sup>1,2,3,4</sup></b>						
Power Added Efficiency, 5.8 GHz	PAE1	19.0	25.8	–	%	V <sub>DD</sub> = 28 V, I <sub>DQ</sub> = 285 mA, P <sub>OUT</sub> = 41 dBm
Power Added Efficiency, 6.4 GHz	PAE2	16.0	22.4	–	%	V <sub>DD</sub> = 28 V, I <sub>DQ</sub> = 285 mA, P <sub>OUT</sub> = 41 dBm
Power Added Efficiency, 7.2 GHz	PAE3	16.2	22.0	–	%	V <sub>DD</sub> = 28 V, I <sub>DQ</sub> = 285 mA, P <sub>OUT</sub> = 41 dBm
Power Added Efficiency, 7.9 GHz	PAE4	18.0	23.9	–	%	V <sub>DD</sub> = 28 V, I <sub>DQ</sub> = 285 mA, P <sub>OUT</sub> = 41 dBm
Power Added Efficiency, 8.4 GHz	PAE5	19.2	25.0	–	%	V <sub>DD</sub> = 28 V, I <sub>DQ</sub> = 285 mA, P <sub>OUT</sub> = 41 dBm
Power Gain, 5.8 GHz	G <sub>P1</sub>	18.25	22.4	–	dB	V <sub>DD</sub> = 28 V, I <sub>DQ</sub> = 285 mA, P <sub>OUT</sub> = 41 dBm
Power Gain, 6.4 GHz	G <sub>P2</sub>	16.35	20.2	–	dB	V <sub>DD</sub> = 28 V, I <sub>DQ</sub> = 285 mA, P <sub>OUT</sub> = 41 dBm
Power Gain, 7.2 GHz	G <sub>P3</sub>	16.85	21.0	–	dB	V <sub>DD</sub> = 28 V, I <sub>DQ</sub> = 285 mA, P <sub>OUT</sub> = 41 dBm
Power Gain, 7.9 GHz	G <sub>P4</sub>	17.15	22.2	–	dB	V <sub>DD</sub> = 28 V, I <sub>DQ</sub> = 285 mA, P <sub>OUT</sub> = 41 dBm
Power Gain, 8.4 GHz	G <sub>P5</sub>	17.65	21.8	–	dB	V <sub>DD</sub> = 28 V, I <sub>DQ</sub> = 285 mA, P <sub>OUT</sub> = 41 dBm
OQPSK Linearity, 5.8 GHz	ACLR1	–	-42	-32	dB	V <sub>DD</sub> = 28 V, I <sub>DQ</sub> = 285 mA, P <sub>OUT</sub> = 41 dBm
OQPSK Linearity, 6.4 GHz	ACLR2	–	-44	-33	dB	V <sub>DD</sub> = 28 V, I <sub>DQ</sub> = 285 mA, P <sub>OUT</sub> = 41 dBm
OQPSK Linearity, 7.2 GHz	ACLR3	–	-34	-27.5	dB	V <sub>DD</sub> = 28 V, I <sub>DQ</sub> = 285 mA, P <sub>OUT</sub> = 41 dBm
OQPSK Linearity, 7.9 GHz	ACLR4	–	-37	-28	dB	V <sub>DD</sub> = 28 V, I <sub>DQ</sub> = 285 mA, P <sub>OUT</sub> = 41 dBm
OQPSK Linearity, 8.4 GHz	ACLR5	–	-40	-32	dB	V <sub>DD</sub> = 28 V, I <sub>DQ</sub> = 285 mA, P <sub>OUT</sub> = 41 dBm

### Notes:

<sup>1</sup> At 25°C

<sup>2</sup> Measurements are to be performed using Cree CMPA5585030F-AMP

<sup>3</sup> Measured using network analyzer (Power = -20 dBm)

<sup>4</sup> Under OQPSK modulated signal, 1.6 Msps, PN23, Alpha Filer = 0.2

<sup>5</sup> Power Added Efficiency = (P<sub>OUT</sub> - P<sub>IN</sub>)/PDC

<sup>4</sup> Fixture loss de-embedded using the following offset. The offset is subtracted from the input offset value and added to the output offset value.

- a. 5.8 GHz - 0.182 dB
- b. 7.2 GHz - 0.217 dB
- c. 7.9 GHz - 0.234 dB
- d. 8.4 GHz - 0.246 dB

## Electrostatic Discharge (ESD) Classifications

Parameter	Symbol	Class	Test Methodology
Human Body Model	HBM	1A (> 250 V)	JEDEC JESD22 A114-D
Charge Device Model	CDM	II (200 < 500 V)	JEDEC JESD22 C101-C

## Typical Performance of the CMPA5585030F

Figure 1. - Gain vs. Frequency & Output Power OQPSK 1.6 Msps  
 $V_{DD} = 28\text{ V}, I_{DQ} = 285\text{ mA}$

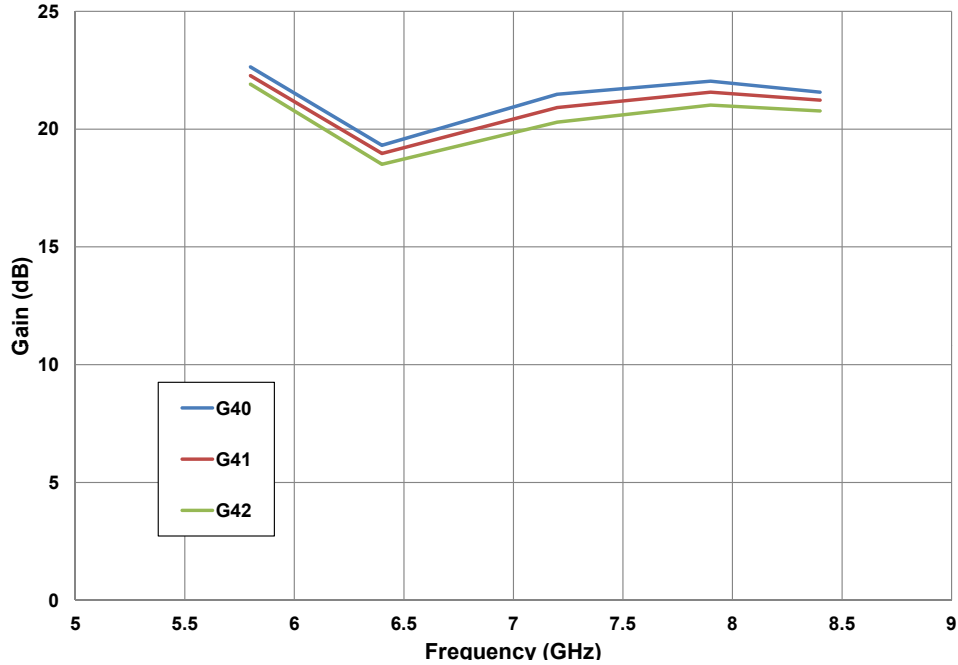
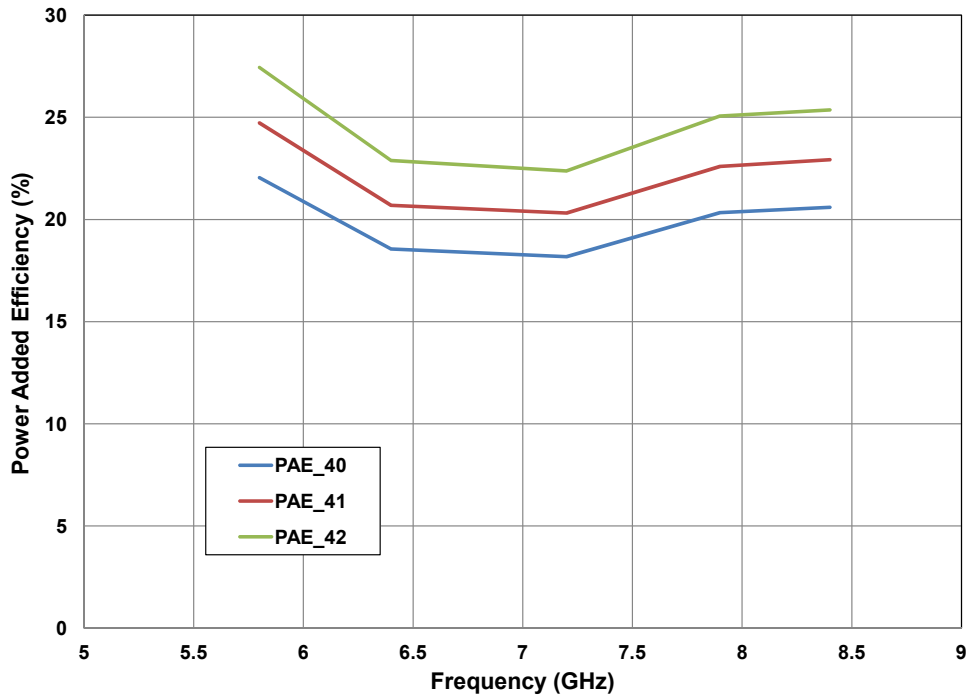
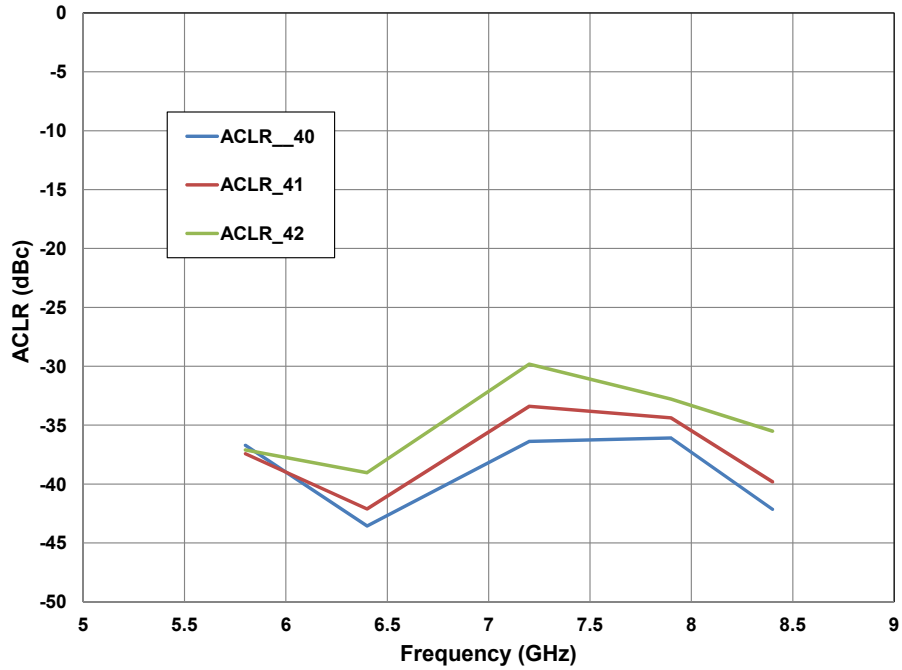

Figure 2. - Power Added Efficiency vs. Frequency & Output Power OQPSK 1.6 Msps  
 $V_{DD} = 28\text{ V}, I_{DQ} = 285\text{ mA}$



## Typical Performance of the CMPA5585030F

**Figure 3. - ACLR vs. Frequency & Output Power OQPSK 1.6 Msps**  
 $V_{DD} = 28\text{ V}, I_{DQ} = 285\text{ mA}$



**Figure 4. - Typical S-Parameters**  
 $V_{DD} = 28\text{ V}, I_{DQ} = 285\text{ mA}$

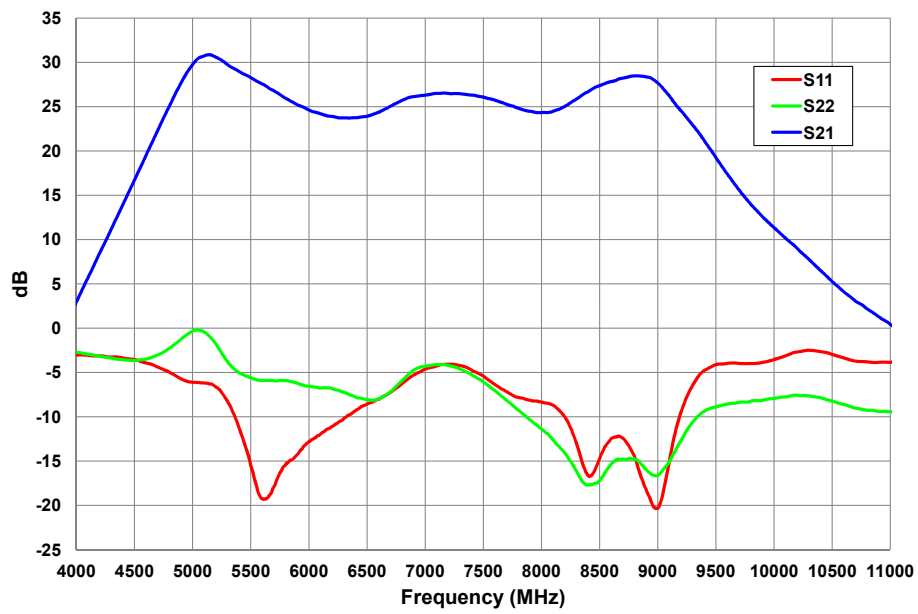

## Typical Performance of the CMPA5585030F

Figure 5. - Gain vs. Output Power and Frequency OQPSK 1.6 Msps  
 $V_{DD} = 28\text{ V}$ ,  $I_{DQ} = 285\text{ mA}$

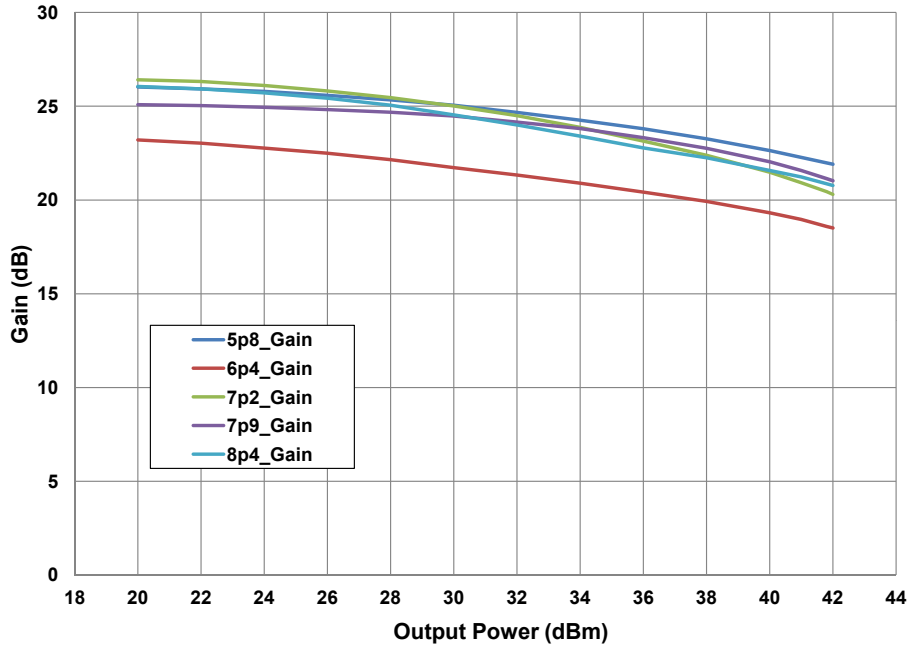
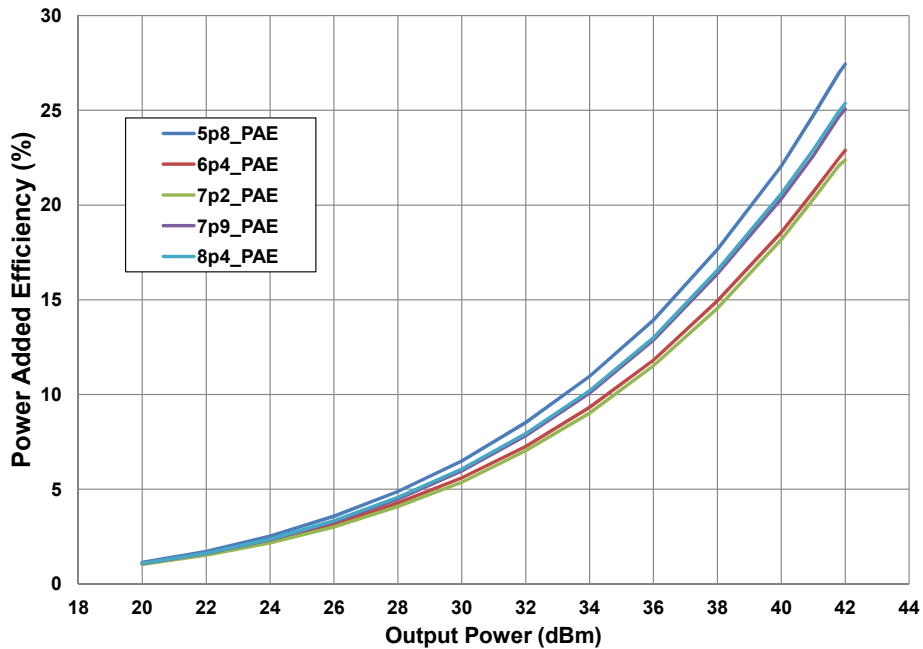

Figure 6. - Power Added Efficiency vs. Output Power and Frequency OQPSK 1.6 Msps  
 $V_{DD} = 28\text{ V}$ ,  $I_{DQ} = 285\text{ mA}$



## Typical Performance of the CMPA5585030F

Figure 7. -ACLR vs. Output Power and Frequency OQPSK 1.6 Msps  
 $V_{DD} = 28\text{ V}$ ,  $I_{DQ} = 285\text{ mA}$

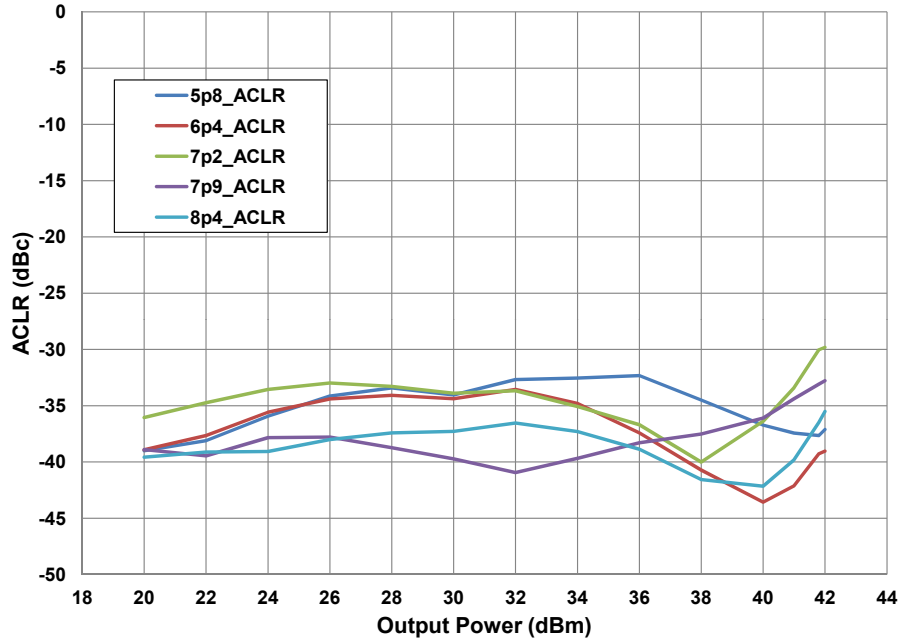
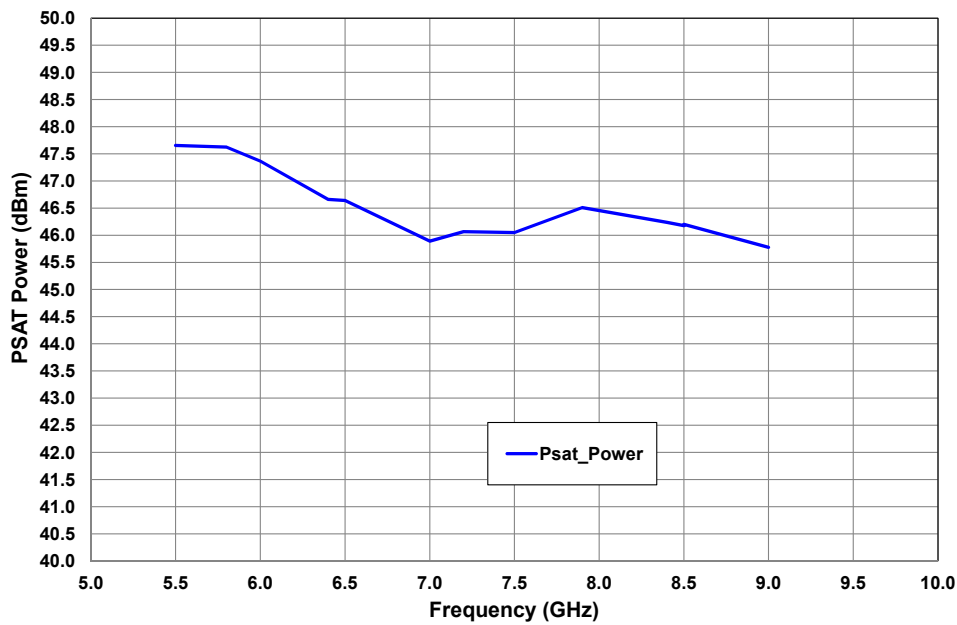
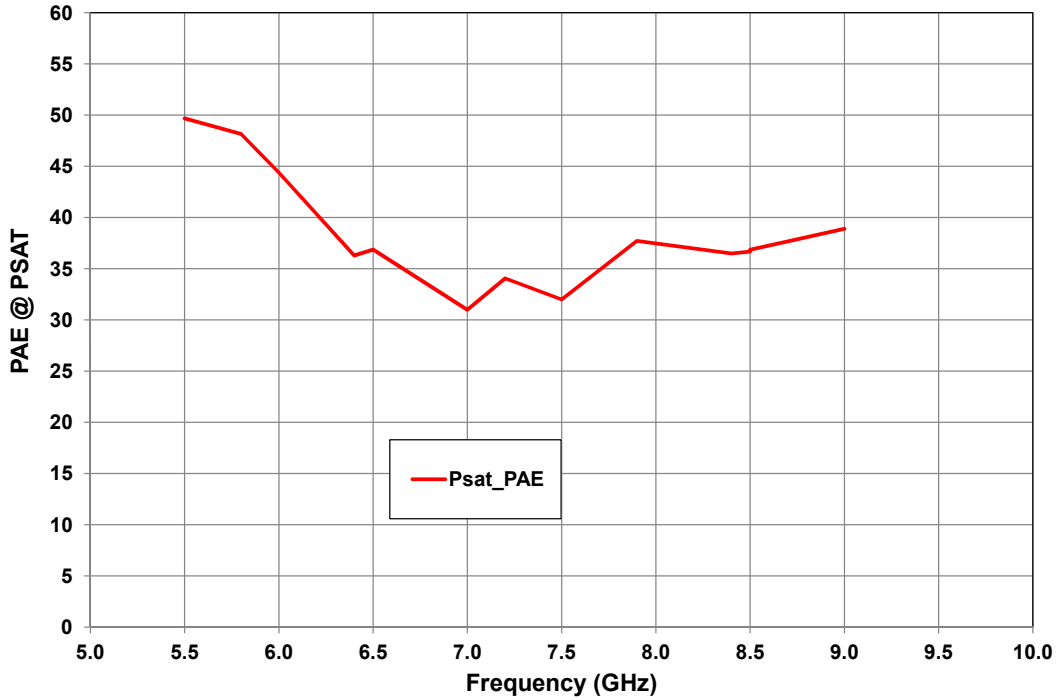

Figure 8. - PSAT Power vs. Frequency  
 $V_{DD} = 28\text{ V}$ ,  $I_{DQ} = 800\text{ mA}$  Pulsed 100  $\mu\text{s}/10\%$



## Typical Performance of the CMPA5585030F

**Figure 9. - PAE @PSAT vs. Frequency**  
 $V_{DD} = 28\text{ V}, I_{DQ} = 800\text{ mA}$  Pulsed 100  $\mu\text{s}/10\%$



**Figure 10. - Gain @PSAT vs. Frequency**  
 $V_{DD} = 28\text{ V}, I_{DQ} = 800\text{ mA}$  Pulsed 100  $\mu\text{s}/10\%$

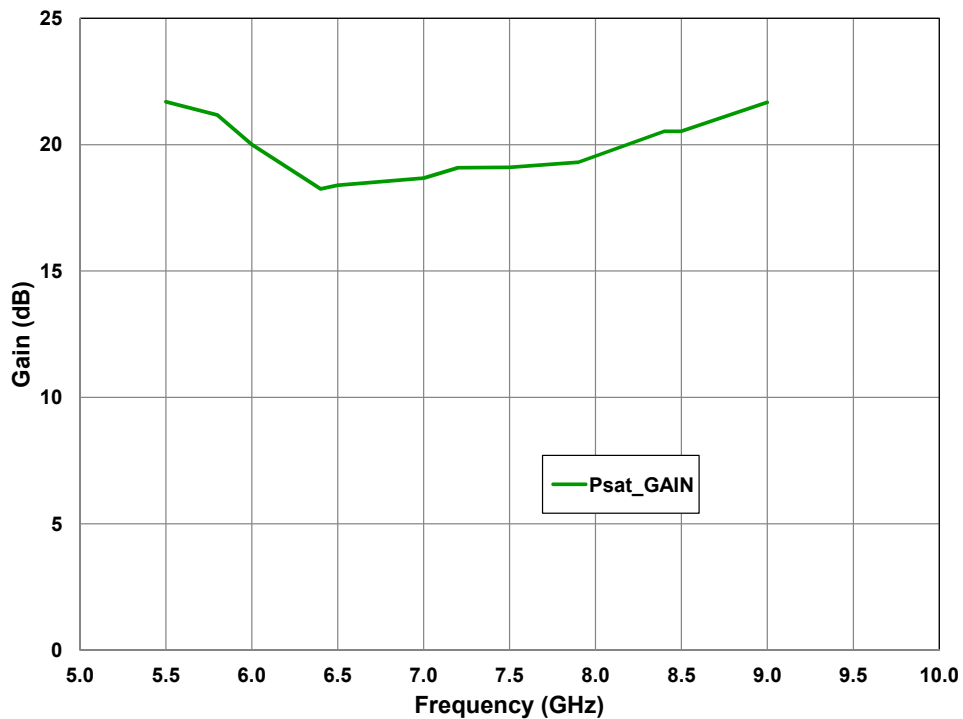



## Typical Performance of the CMPA5585030F

**Figure 11. PAE vs. Output Power and Frequency**  
 $V_{DD} = 28\text{ V}$ ,  $I_{DQ} = 800\text{ mA}$  Pulsed 100  $\mu\text{s}/10\%$

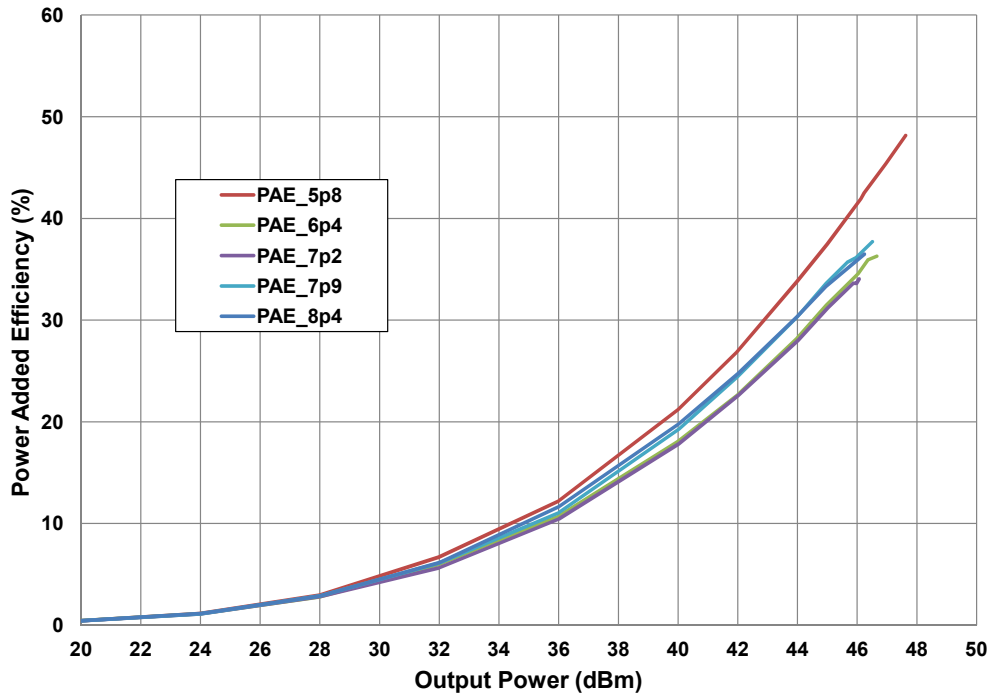

**Figure 12. Gain vs. Output Power and Frequency**  
 $V_{DD} = 28\text{ V}$ ,  $I_{DQ} = 800\text{ mA}$  Pulsed 100  $\mu\text{s}/10\%$

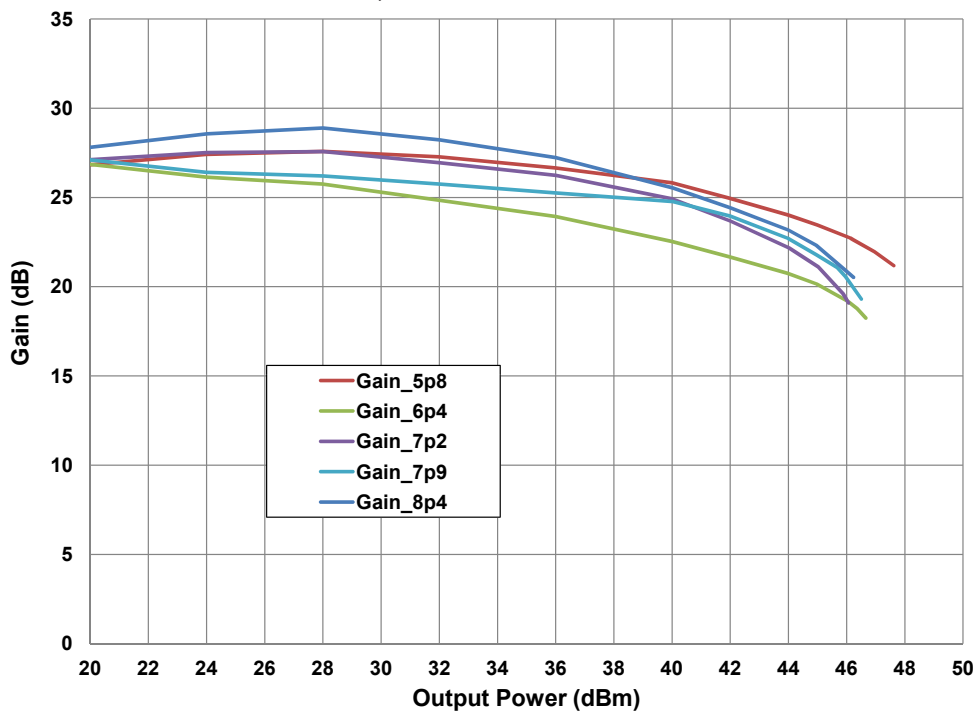

## CMPA5585030F Power Dissipation De-rating Curve

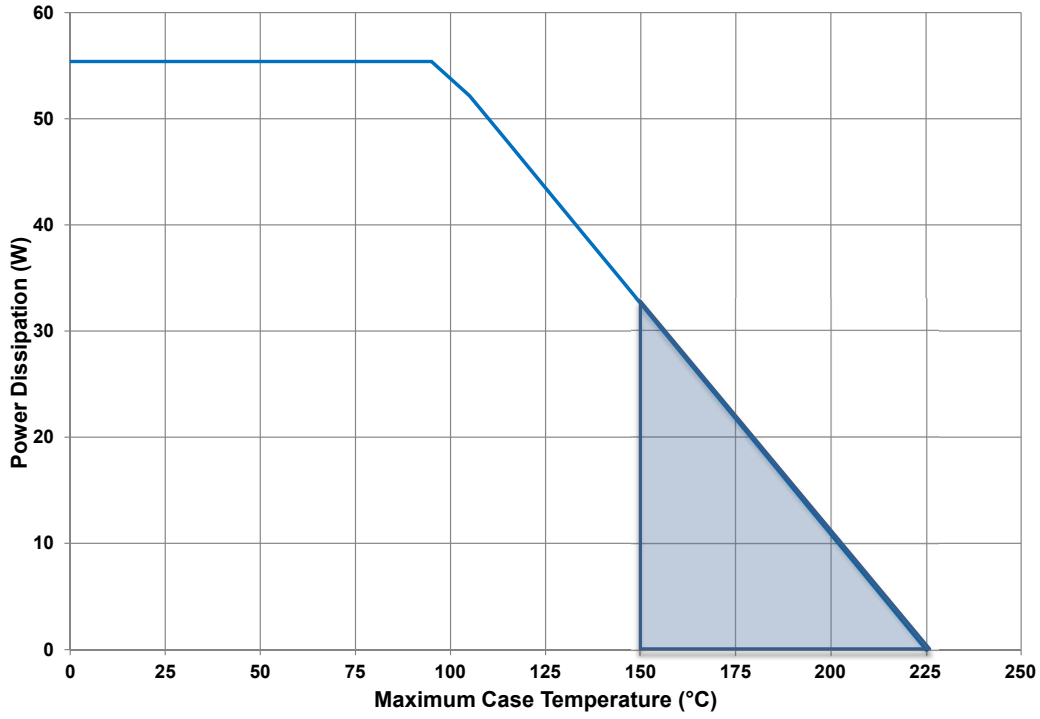

Note 1. Area exceeds Maximum Case Operating Temperature (See Page 2).

## CMPA5585030F-AMP Demonstration Amplifier Circuit Bill of Materials

Designator	Description	Qty
C1, C3, C7, C8, C10, C13	CAP, 1.0 uF, +/-10%, 1210, 100V, X7R	6
C2, C4, C5, C6, C9, C12	CAP, 33000 pF, 0805, 100V, X7R	6
C11, C14	CAP ELECT 3.3UF 80V FK SMD	2
R1, R2	RES 0.0 OHM 1/16W 0402 SMD	2
J1,J2	CONN, SMA, PANEL MOUNT JACK, FLANGE, 4-HOLE, BLUNT POST, 20MIL	2
J3	CONNECTOR, HEADER, RT>PLZ .1CEN LK 9POS	1
-	PCB, TACONIC, RF-35P-0200-CL1/CL1	1
Q1	CMPA5585030F	1

## CMPA5585030F-AMP Demonstration Amplifier Circuit

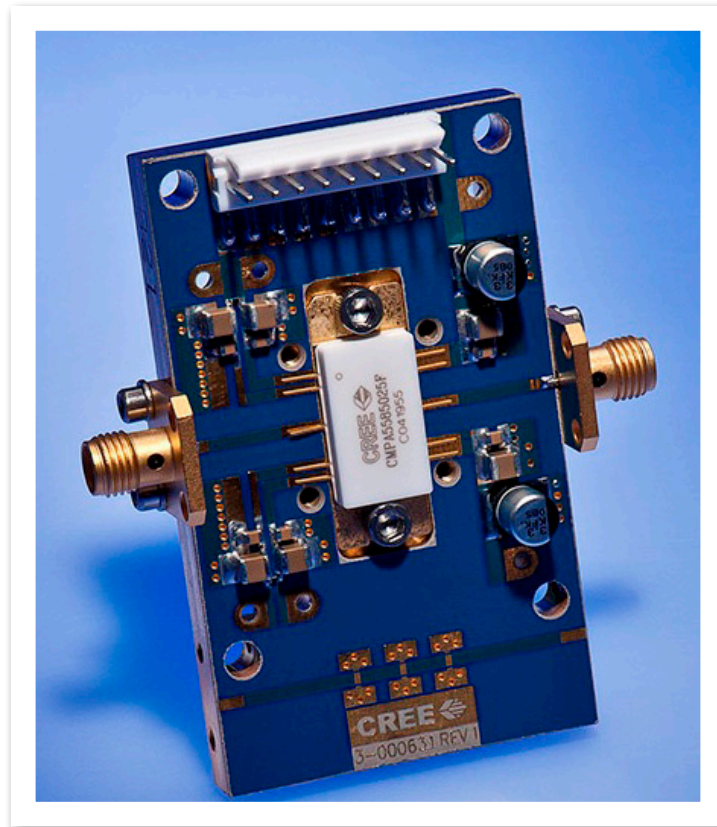

## CMPA5585030F-AMP Demonstration Amplifier Circuit

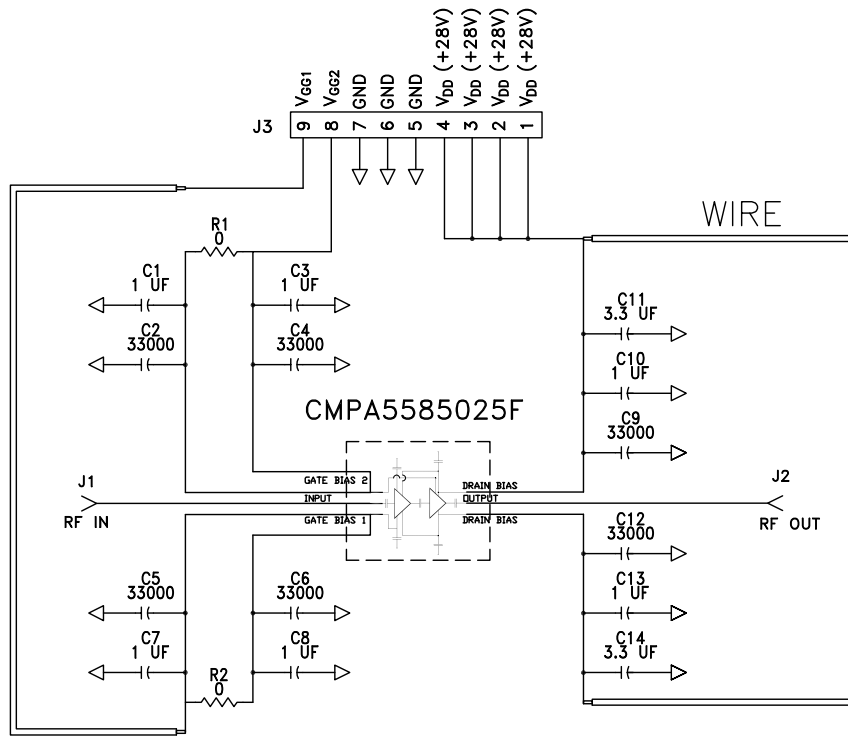

## CMPA5585030F-AMP Demonstration Amplifier Circuit Outline

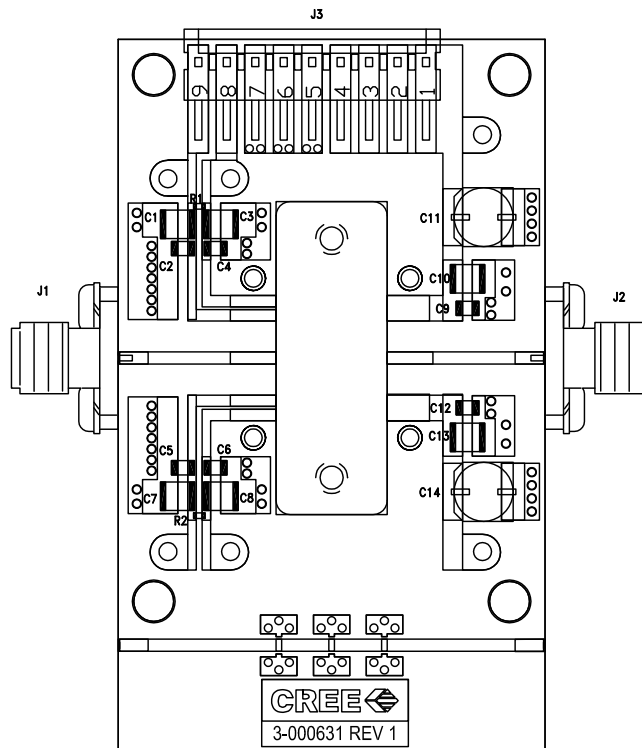

## CMPA5585030F-AMP Demonstration Amplifier Circuit

To configure the CPM5585030F test fixture to enable independent  $V_{G1}$  /  $V_{G2}$  control of the device, a cut must be made to the microstrip line just above the R1 resistor as shown. Pin 9 will then supply  $V_{G1}$  and Pin 8 will supply  $V_{G2}$ .

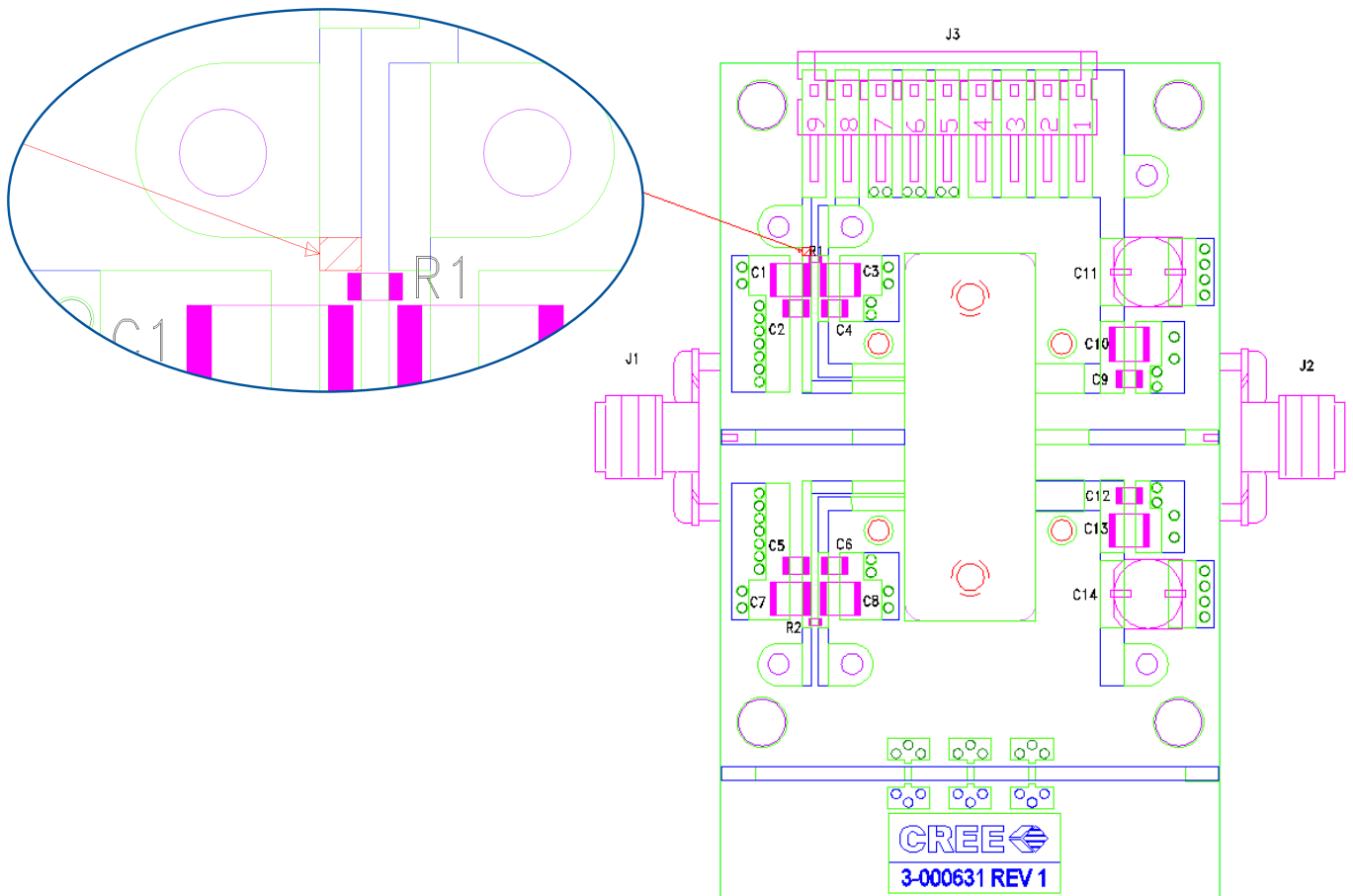

## Product Dimensions CMPA5585030F (Package Type – 440213)

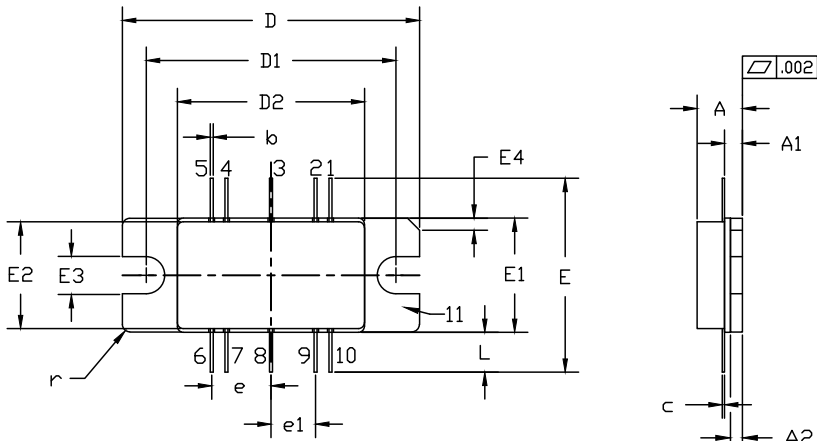

### NOTES:

1. DIMENSIONING AND TOLERANCING PER ANSI Y14.5M - 1994.
2. CONTROLLING DIMENSION: INCH.
3. ADHESIVE FROM LID MAY EXTEND A MAXIMUM OF 0.020" BEYOND EDGE OF LID.
4. LID MAY BE MISALIGNED TO THE BODY OF PACKAGE BY A MAXIMUM OF 0.008" IN ANY DIRECTION.

DIM	INCHES		MILLIMETERS		NOTES
	MIN	MAX	MIN	MAX	
A	0.148	0.168	3.76	4.27	
A1	0.055	0.065	1.40	1.65	
A2	0.035	0.045	0.89	1.14	
b	0.01 TYP		0.254 TYP		10x
c	0.007	0.009	0.18	0.23	
D	0.995	1.005	25.27	25.53	
D1	0.835	0.845	21.21	21.46	
D2	0.623	0.637	15.82	16.18	
E	0.653 TYP		16.59 TYP		
E1	0.380	0.390	9.65	9.91	
E2	0.355	0.365	9.02	9.27	
E3	0.120	0.130	3.05	3.30	
E4	0.035	0.045	0.89	1.14	45° CHAMFER
e	0.200 TYP		5.08 TYP		4x
e1	0.150 TYP		3.81 TYP		4x
L	0.115	0.155	2.92	3.94	10x
r	0.025 TYP		.635 TYP		3x

Pin Number	Qty
1	Gate Bias for Stage 2
2	Gate Bias for Stage 2
3	RF In
4	Gate Bias for Stage 1
5	Gate Bias for Stage 1
6	Drain Bias
7	Drain Bias
8	RF Out
9	Drain Bias
10	Drain Bias
11	Source

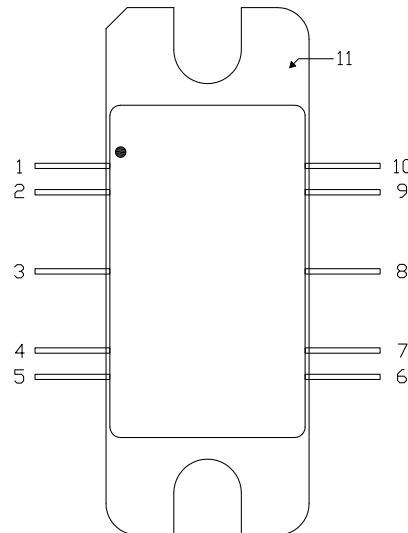

## Part Number System

### CMPA5585030F

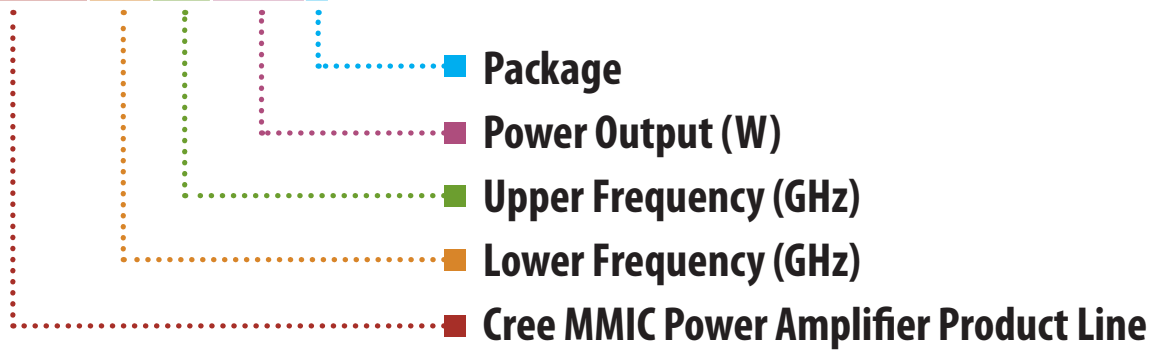

Parameter	Value	Units
Lower Frequency	5.5	GHz
Upper Frequency <sup>1</sup>	8.5	GHz
Power Output	30	W
Package	Flange	-

**Table 1.**

**Note<sup>1</sup>:** Alpha characters used in frequency code indicate a value greater than 9.9 GHz. See Table 2 for value.

Character Code	Code Value
A	0
B	1
C	2
D	3
E	4
F	5
G	6
H	7
J	8
K	9
Examples:	1A = 10.0 GHz 2H = 27.0 GHz

**Table 2.**

## Product Ordering Information

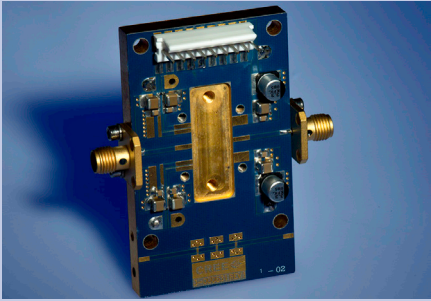
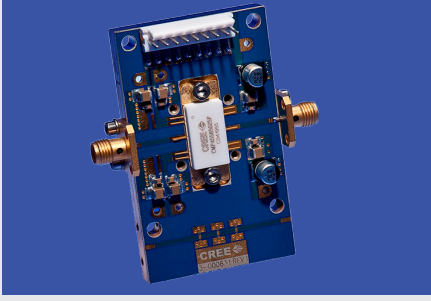
Order Number	Description	Unit of Measure	Image
CMPA5585030F	GaN MMIC	Each	
CMPA5585030F-TB	Test board without GaN MMIC	Each	
CMPA5585030F-AMP	Test board with GaN MMIC installed	Each	





## Disclaimer

Specifications are subject to change without notice. Cree, Inc. believes the information contained within this data sheet to be accurate and reliable. However, no responsibility is assumed by Cree for its use or for any infringement of patents or other rights of third parties which may result from its use. No license is granted by implication or otherwise under any patent or patent rights of Cree. Cree makes no warranty, representation or guarantee regarding the suitability of its products for any particular purpose. "Typical" parameters are the average values expected by Cree in large quantities and are provided for information purposes only. These values can and do vary in different applications, and actual performance can vary over time. All operating parameters should be validated by customer's technical experts for each application. Cree products are not designed, intended, or authorized for use as components in applications intended for surgical implant into the body or to support or sustain life, in applications in which the failure of the Cree product could result in personal injury or death, or in applications for the planning, construction, maintenance or direct operation of a nuclear facility. CREE and the CREE logo are registered trademarks of Cree, Inc.

For more information, please contact:

Cree, Inc.  
4600 Silicon Drive  
Durham, North Carolina, USA 27703  
[www.cree.com/RF](http://www.cree.com/RF)

Sarah Miller  
Marketing  
Cree, RF Components  
1.919.407.5302

Ryan Baker  
Marketing & Sales  
Cree, RF Components  
1.919.407.7816

Tom Dekker  
Sales Director  
Cree, RF Components  
1.919.407.5639